

TREND Modular Sauna

Owners Manual and Installation Guide

Custom Backyard Spaces

Your Authorized Am-Finn Dealer in North Carolina

www.CustomBackyardSpaces.com

919-444-8500



AM~FINN
RESIDENTIAL

Dear Valued Customer:

Congratulations on purchasing one of the finest home sauna units available. We appreciate your business and hope you enjoy your sauna. Follow this guide to assemble your sauna correctly and for instructions on how to use the various components. Please feel free to reach out to us with any questions or problems, and we will do our best to assist you.

Am-Finn Residential Team: +1(888)691-5470

Recommendations before assembly:

- Read and follow all the instructions before assembling your Trend Sauna.
- The assembly must be done by two people at minimum.
- Avoid using the force as to not strip the wood.
- The installation ground must be leveled, dry and clean.
- Keep this document for any future questions or issues.
- You will need the below tools:
 - Rubber mallet
 - Screw Gun and Bits
 - Flat Head Screwdriver

**WARNING! Electrical Hazard**

- Every electrical adjustment done during the installation has to be done by a certified technician. Improper manipulation of AC power could cause damage to your electrical installation and will cause very serious injuries to an unexperienced installer.
- Before starting the installation, make sure you have 220v single phase available and a NEMA 10-30R wall plug, the electrical wiring has to be done with a wire gauged between 10 AWG – 4 AWG and properly grounded.

Recommendations after assembly:

- Try to minimize moving the Trend Sauna after assembly.
- Do not operate the Trend Sauna under the influence of alcohol or any mind altering substance.
- Children must be accompanied by an adult at all times inside the sauna.
- The Trend Sauna is intended for INDOOR USE only.
- Do not touch the sauna heater.
- Do not turn on the heater until the sauna is assembled.
- Do not exceed the maximum recommended number of people inside the sauna.
- Before maintenance or cleaning ensure the sauna heater is off.
- Do not use abrasive cleaners, flammable products, steel wool, or any other cleaner that compromises the integrity of the wood. Am-Finn recommends a combination of 4 parts water to 1 part apple cider vinegar as a cleaning product. Use Scandia Sauna Oil to protect surfaces from wear and tear.
- Do not spray down the sauna with a hose or power washer.
- Do not stand or jump on the benches.
- Am-Finn Residential is not responsible for any damage or injury caused by misuse or mis-installation of the Trend Sauna.

Parts List

You will receive the following inside your Trend Modular Sauna Kit.

Overall Frame and System:

- 1.- 2 x Top Corner Piece
- 2.- 2 x Bottom Corner Piece
- 3.- 2 x Wall Panel
- 4.- 1 x Floor Panel
- 5.- 1 x Ceiling Panel
- 6.- 1 x Back Right Panel
- 7.- 1 x Back Left Panel

Door and Storefront

- 1.- 1 x Full Glass Door
- 2.- 1 x Left Storefront with Hinge Cutout
- 3.- 1 x Right Storefront without Hinge cutout
- 4.- 1 x Storefront Frame Back
 - a. 1 x Top Piece
 - b. 1 x Bottom Piece
 - c. 1 x Left Piece
 - d. 1 x Right Piece
- 5.- 1 x Storefront Frame Front
 - a. 1 x Top Piece
 - b. 1 x Bottom Piece
 - c. 1 x Left Piece
 - d. 1 x Right Piece

Other Parts and Bits

- 1.- 1 x Scandia Ultra Sauna Heater
- 2.- 1 x Wifi Controller
- 3.- 1 x Control Relay Box
- 4.- 2 x Vent Covers (2)
- 5.- 3 x Electric Cap Covers
- 6.- 1 x Magnetic Door Stop
- 7.- 2 x Frosted Glass Cover for Corner LEDs
- 8.- 1 x Door Handle
- 9.- 2 x Door Hinges
- 10.- 2 x Sauna Bench
 - a. 2 x Sauna Bench Top (2)
 - b. 4 x Sauna Bench Legs (4)
- 12.- 1 x Heater Guard Rail
- 13.- Pink Foam (4)
- 14.- Fasteners
 - a. Back Panel Screws (25 pieces 2.5")
 - b. Bench Pocket Hole Screws (10 pieces 2.5")
 - c. Storefront Frame Back Screws (30 pieces 1.5")
 - d. Frame Staples (16 pieces 1.5")

Expanded View

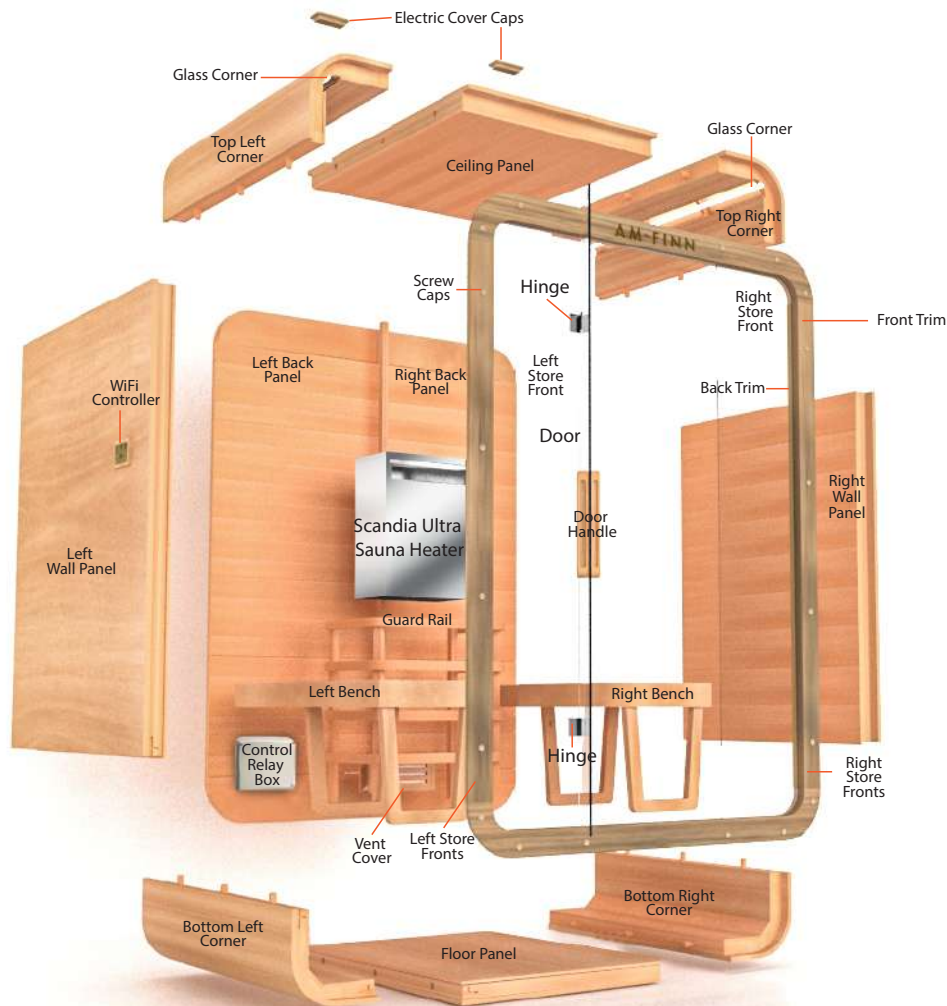

Step 1: Assemble the Frame

Assemble the floor panel together with the lower corner panels. Make sure the floor panel fits and aligns correctly with the lower corner panels.

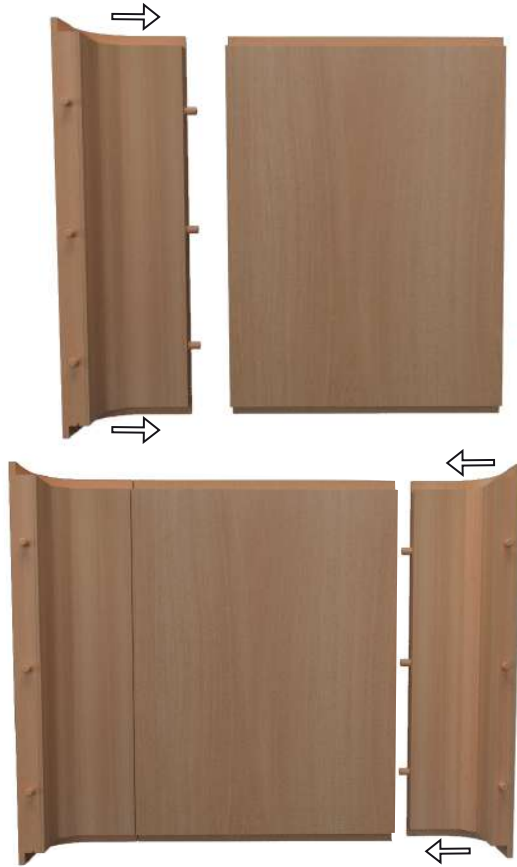

1.1: Place 2 staples in the slots to secure the floor panel with the lower corner panels.



1.2: Once the first 2 staples are in place, carefully and with the help of another person, flip the pieces without separating them.



1.3: Place 2 staples in the slots to secure the floor panel with the lower corner panels.



1.4: Once the first 2 staples are in place, carefully and with the help of another person, flip the pieces without separating them.



Step 2

IMPORTANT: Place the lower interior trim over both sides of the base.

Verify that there are no gaps between the trim, the floor and corner panels. Then, one person should hold it in place while the other one drills the screws in the slots.



Step 3: Assembling the roof

Assemble the ceiling panel and the upper corner panels together.

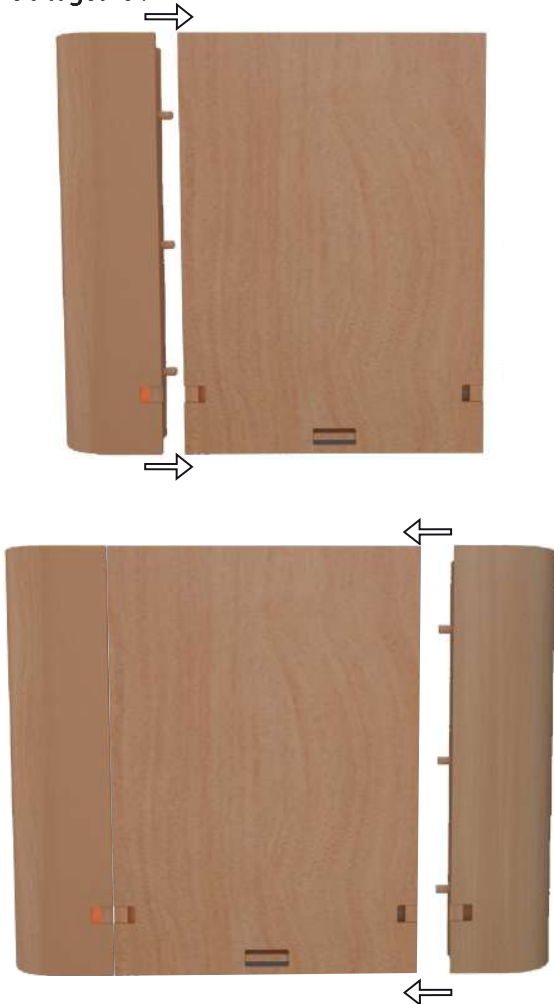

3.1: Place the staples in the nearest side of the slots (the back).



3.2: With the help of another person, flip the pieces and place the next staples.



3.3: Place the staples in the slots.



3.4: Next, screw the inner upper frame in the same manner as step 2. Place the upper interior trim the same way as the base.



3.5: With the help of another person, flip the pieces and place the next staples, again.



3.6: Place both glasses.

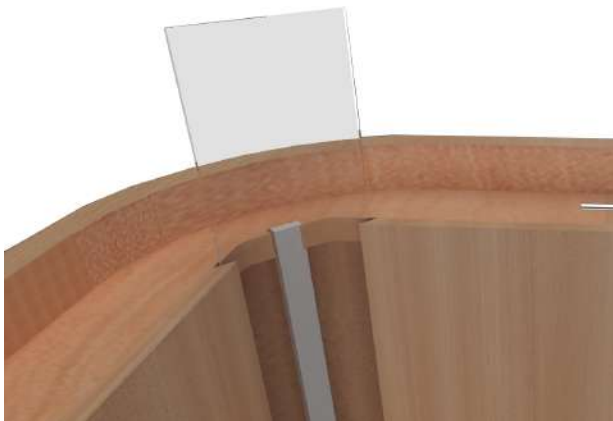

Step 4

Place the floor panel 4'½ from the wall where the sauna is to be placed definitively.

Incline the base slightly and place the pink squares below the base as shown in the picture.



4.1: Fit the left wall to the base (the position is labeled on the piece).

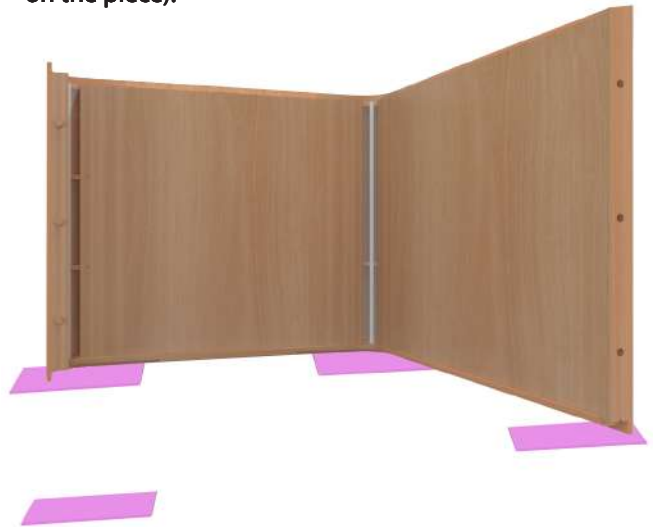

4.2: Place the respective staple to secure the union.



4.3: Repeat this process with the right wall always using the labels as reference (this side up/down).



4.4: Place the respective staple to secure the union.

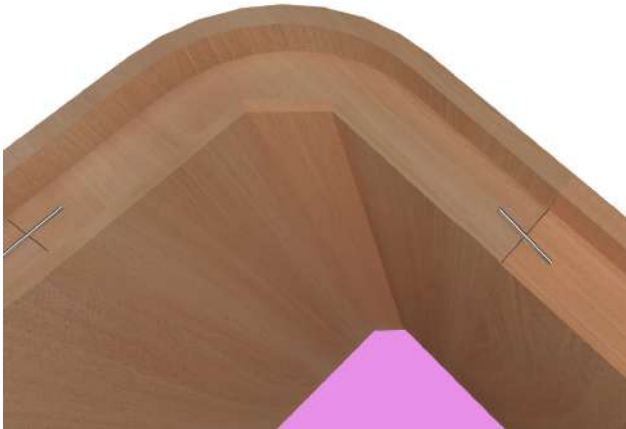

4.5: Join the ceiling to the walls and place the respective staples.



Step 5. Back Panels

Place the left back panel on top of the ring.



5.1: Place the upper piece near first and slide the cable in.

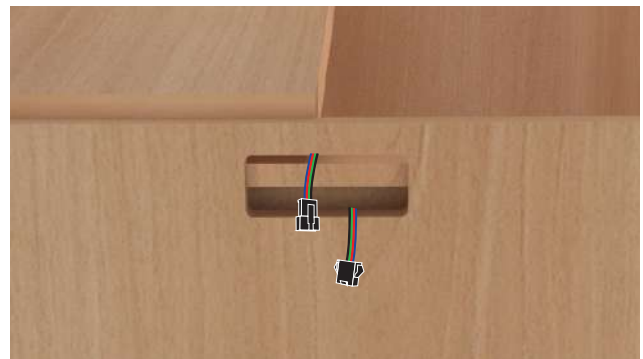

5.2: Place the back right panel



5.3: Make sure the vent hole is perfectly aligned



5.4: Screw the screws to the back panels.



Step 6
Connect all the cables found in the ceiling and place the Electric Cover Caps.

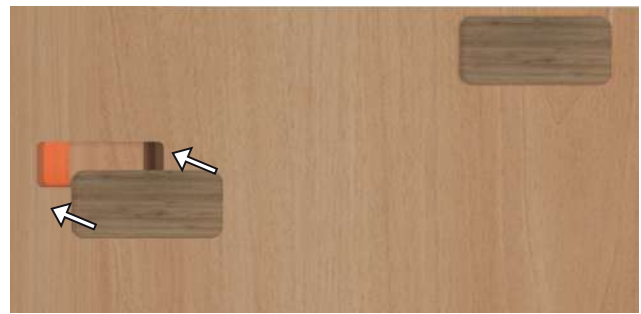
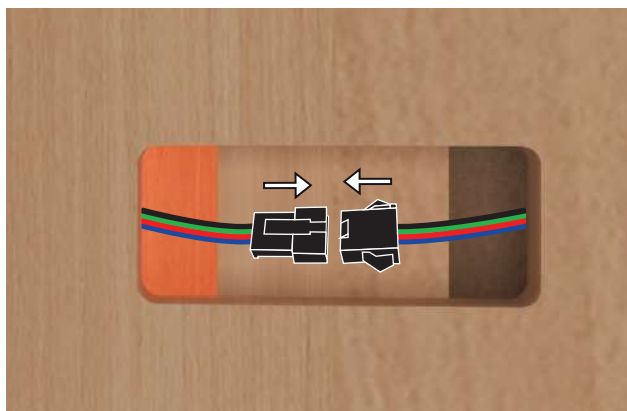

Step 7

Place the Left Back Panel cable in the space of the Vent Cover. Instead of between two people tilt back the Sauna into the up right position (in a squat position to avoid injuries) and lift the sauna. Place your right and left hands as seen below.

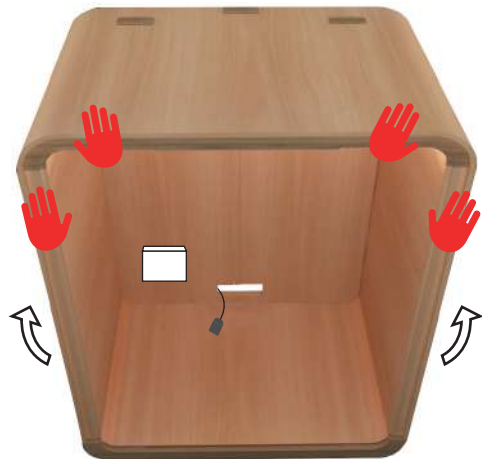

Step 8

Set in place the last 4 staples in the union of the walls with the corners.



Step 9

Screw the interior legs of the trim.



Step 10

Set both vents in place



Step 11: Heater

Use the drill to place the heater above the floor centered with the vent cover.



Step 12: Assembling the benches

Screw the legs to the trim, then screw the trim to the Trend Sauna and secure the respective lids.

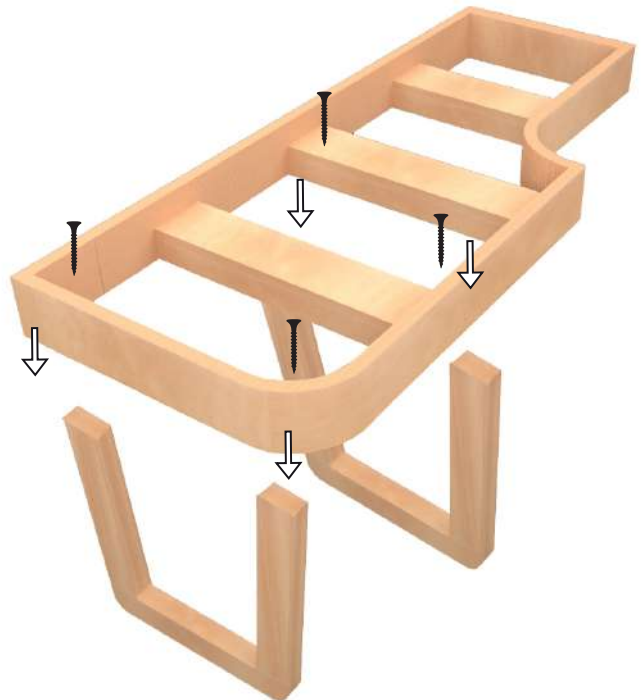



Step 13: Guard Rail

Screw the guard rail pieces as shown and set the Guard Rail in front assembled to the Heater.



Step 14

Screw the guard rail and set in place in front of the heater and drill to the Trend Sauna

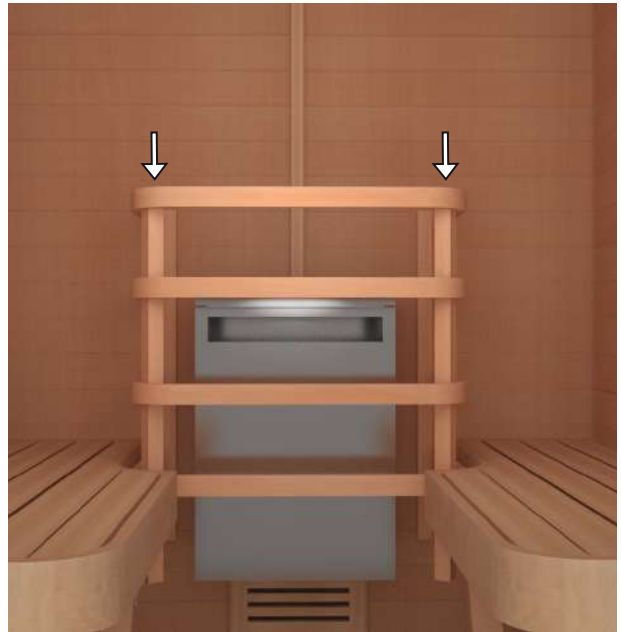

Step 15: Outside trim

ONE BY ONE, ALWAYS HOLDING DOWN THE PIECES
Screw the lower exterior trim.



Partially drill the left exterior leg.

Step 16

Determine the door swing direction of your door and place the glasses accordingly. Place the internal corner of the glass in the space between the back and front trim. Tighten the screws on the left and right sides of the front Front Trim after placing the glasses.



Step 17

Screw the upper exterior trim that has the logo.



Step 18: Hinges

Remove the screws from the hinge on the right side as shown in the picture.

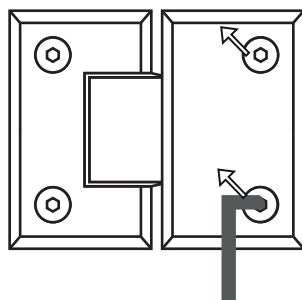

18.1: Remove the black rubber and make sure that the thick gray plastic is in place.

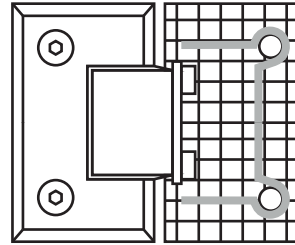

18.2: Place the thinner rubber protector over the thicker rubber protector (the thinner rubber protector will be in contact with the glass).

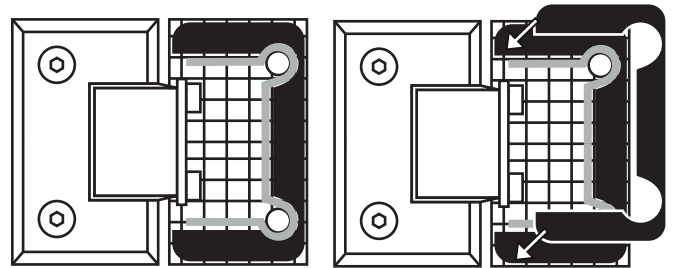

18.3: Place the thinner rubber protector over the thicker plastic protector (the thinner plastic protector will be in contact with the glass).

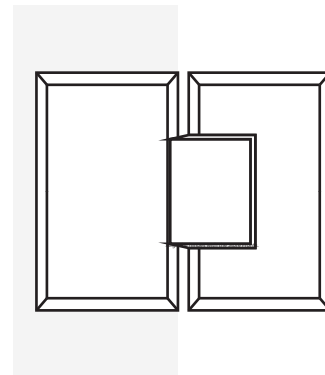

18.4: Place the cap on the back of the hinge and screw back on.

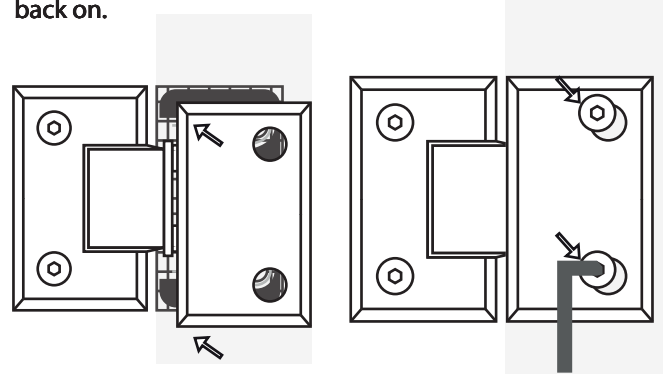

18.5: Remove the back cover from the other end of the hinge.

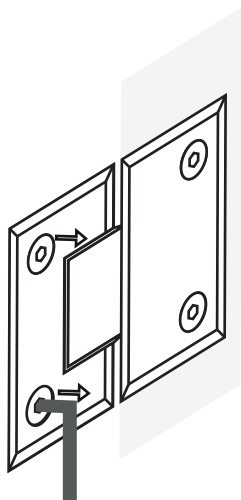

18.6: Align the door with the hinges.

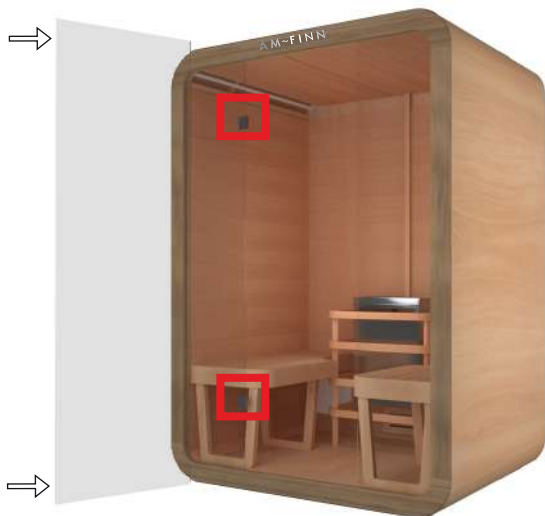

18.7: Place the cap on the back of the hinge and screw back on.

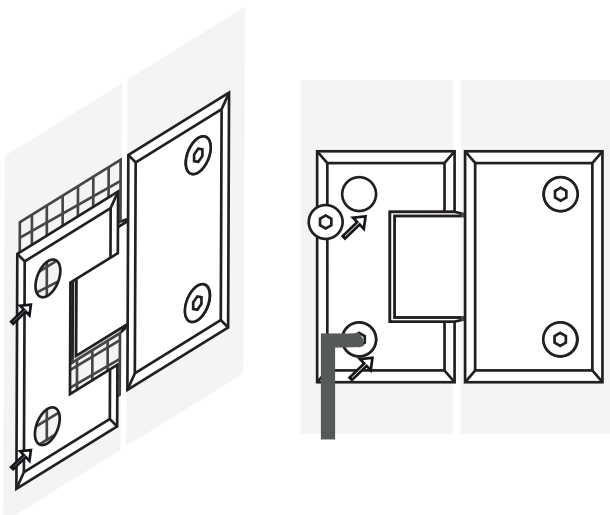

Step 19

Place the polycarbonate seal.

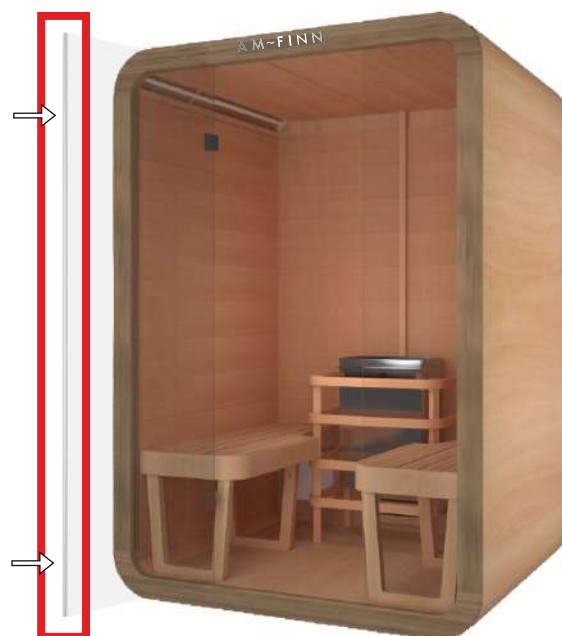

Step 20: Magnetic Stop

Remove the small magnet from the large magnet and Place the key in the right orifice of the big magnet and twist until the pieces are separated.

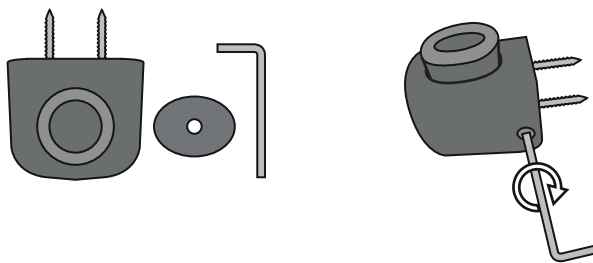

20.1: Take the flat piece where the screws are located, remove them and place the piece on the external upper trim, center it as much as possible with the door and screw.

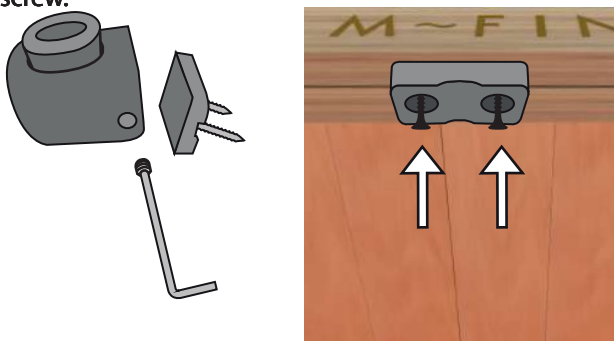

20.2: Assemble the large magnet to the flat piece.

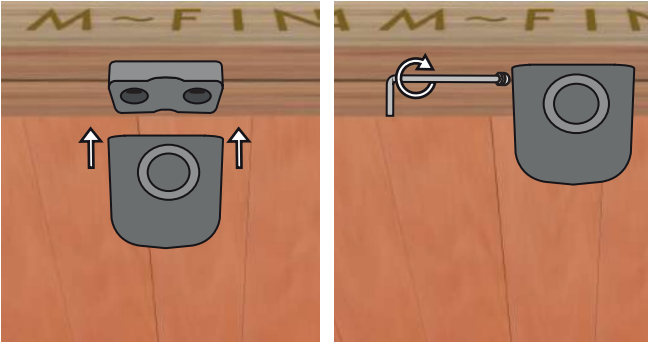

20.3: Use the special glass glue (included) to paste the oval shaped metal washer at the same height of the metallic door stop.

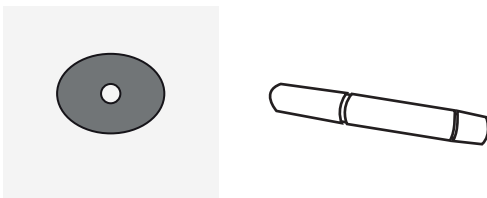

Step 21: Screw Caps

Place the screw caps on the external trim to cover the holes.



Step 22: Control Relay Box

Connect the cables to the Control Relay Box.

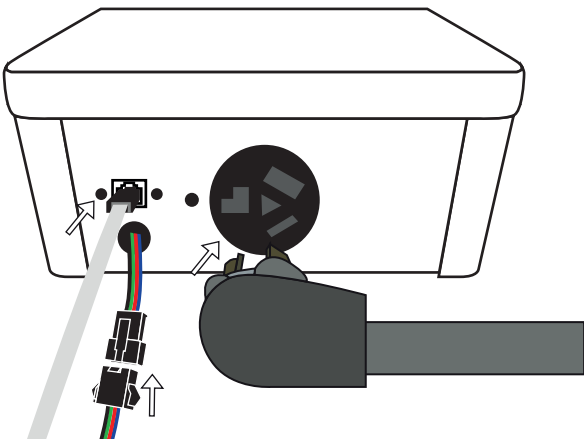

Step 23

Ensure you have a 220V 10AWG - 4 AWG plug.



Step 24

If you have this kind of plug (220V 10AWG - 4AWG), connect your Trend Modular Sauna.



WARNING! Electrical Hazard

Step 25

If you're not sure that your home has a 220V 10 AWG - 4 AWG, call your certified electrician to make the appropriate changes.

Materials required for the installation:

- Nema 10-30R (1 piece).

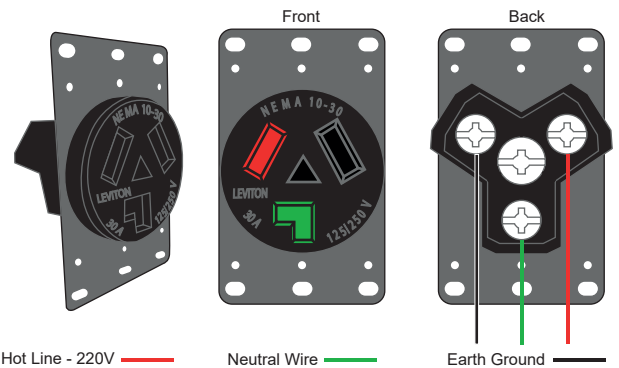

Disclaimer:

- All electrical modifications necessary for your home have to be done by a certified electrician.
- To avoid property damage, the electrical installation must be grounded.

Note:

The amount of cables and other materials used will be determined by your certified electrician.

Step 26

Make sure your Trend Modular Sauna is plugged into a 220V current.

Wifi Heater Controller

To enjoy the Trend Modular Sauna, it is essential to learn how to operate the WiFi Heater Controller located outside the Left Wall Panel.

Step 27: Use the sliders to adjust the temperature and time as you desire.

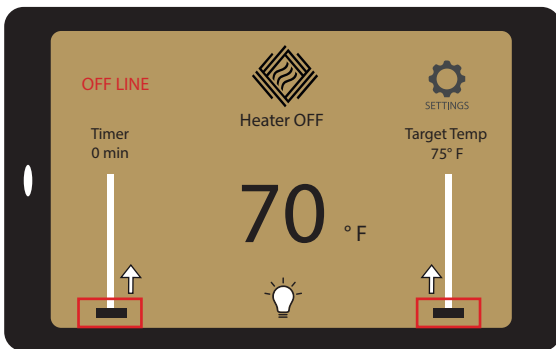

27.1: Once the indicator is replaced by the "Turn Off" button and the Am-Finn icon starts its animation, the heater will be turned on.

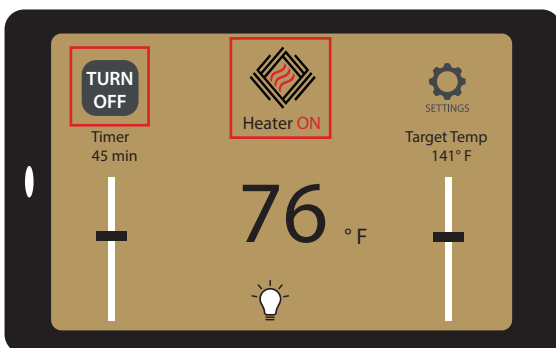

Step 28: Cloud Set up

Press the settings icon (gears).

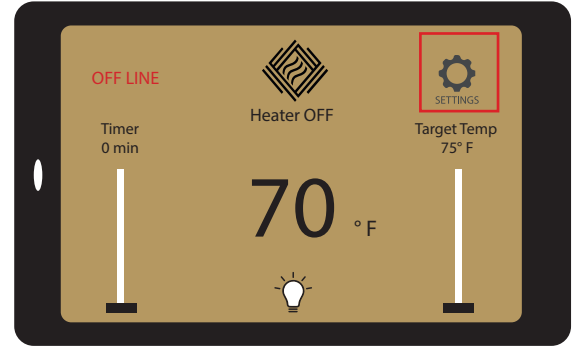

28.1: Select cloud.

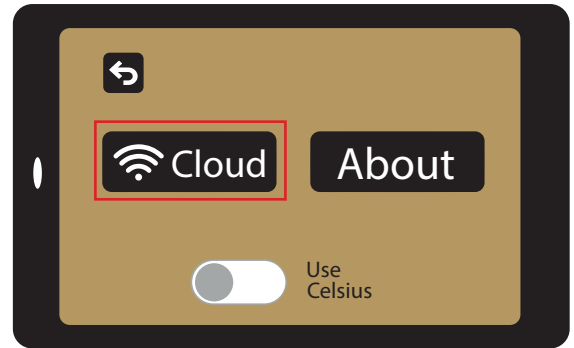

28.2: Scan the available networks.

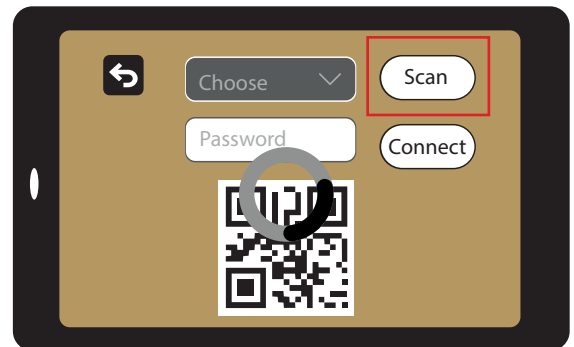

28.3: Select the network of your preference.

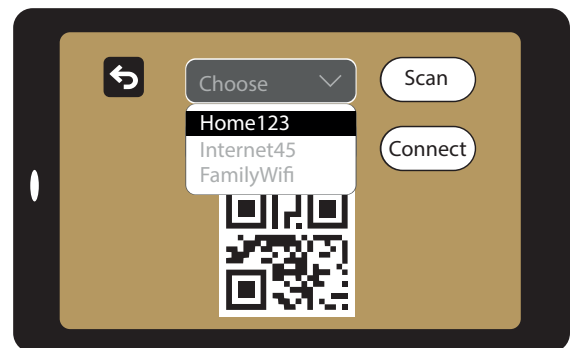

28.4: Enter the password and press "Connect".

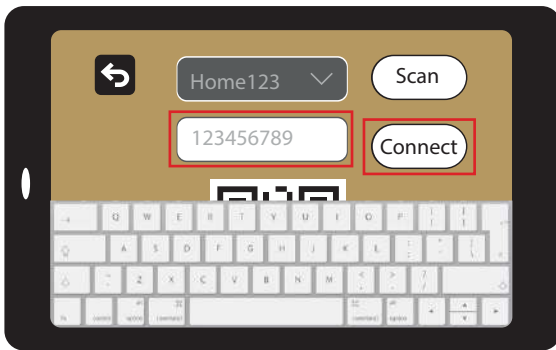

Step 29: Lights Set up
Press the Lightbulb icon.

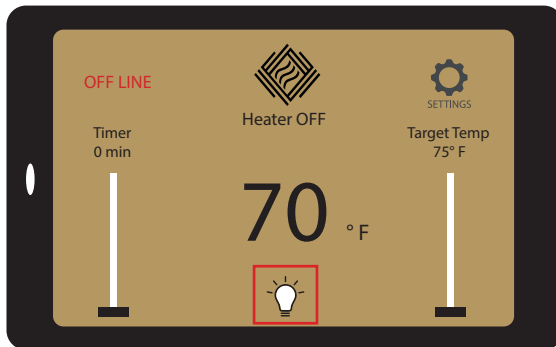

29.1: Select the color of your preference using the color bar and adjust the brightness.

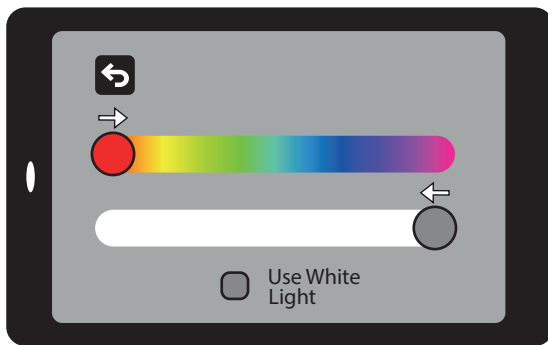

29.2: If you wish to use white lighting, press the "Use White Light" button.

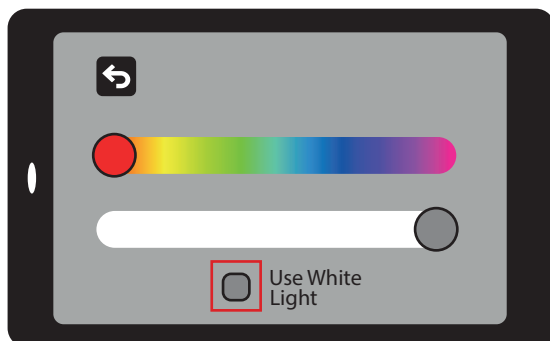

Step 30: If you wish to change the temperature units, press the settings icon.

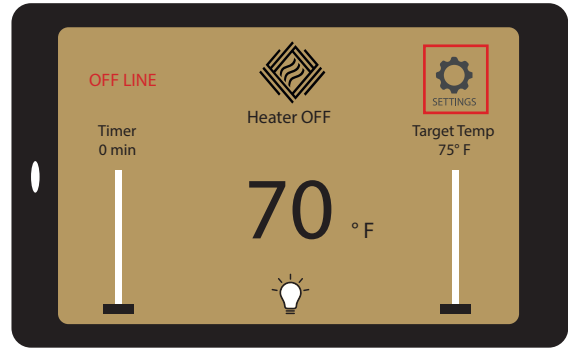

30.1: Slide the switch.

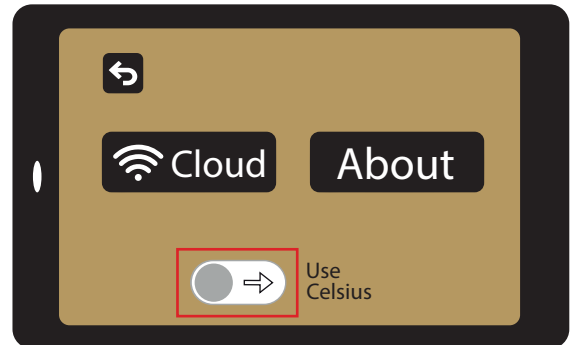

Step 31: If you wish to contact customer service, Press the Settings Icon.

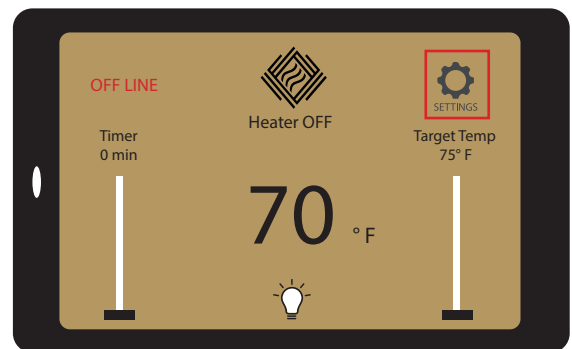

31.1: Press the "About" button.

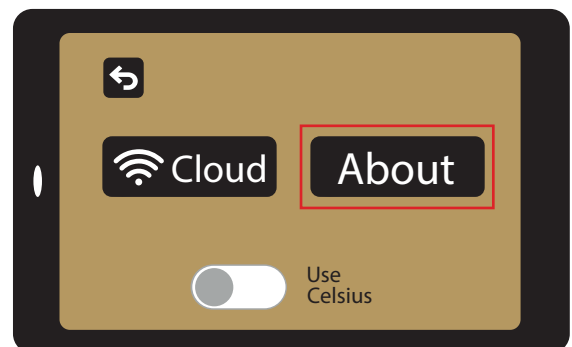

31.2: You will find the contact information for customer service and the model number of your Trend Modular Sauna.



Smart Sauna App User Manual

After installing and connecting your Trend Sauna to Wi-Fi network, the next step is to synchronize it to your Smart Phone.

Step 32: Download the Smart Sauna App available in the App store and Google Play.

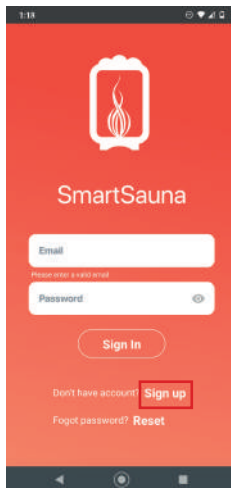
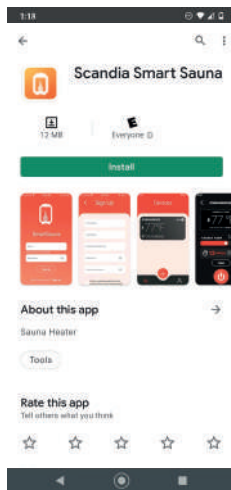

32.1: Create your account.

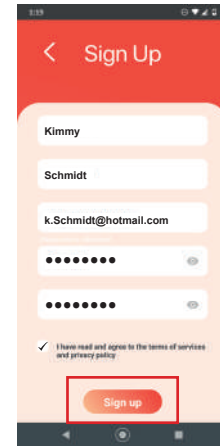

32.2: Check the confirmation email in your mailbox.



32.3: Access your account with your email address and your password.

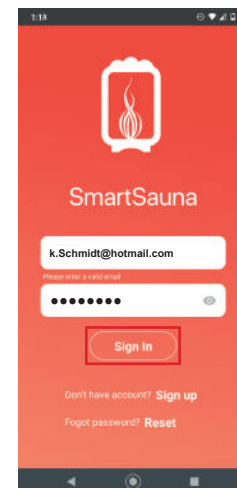

32.4: Press the + icon.

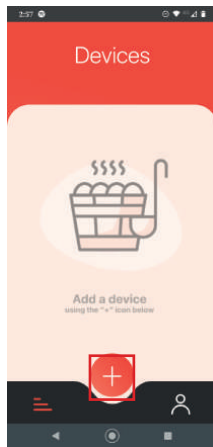

32.5: Press the QR code icon.

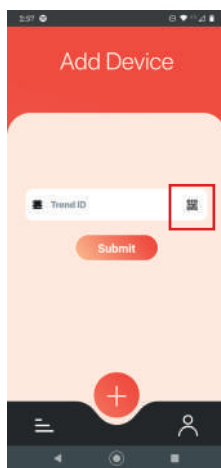

32.6: Scan the QR code located in the WiFi Controller:

- Settings
- Cloud

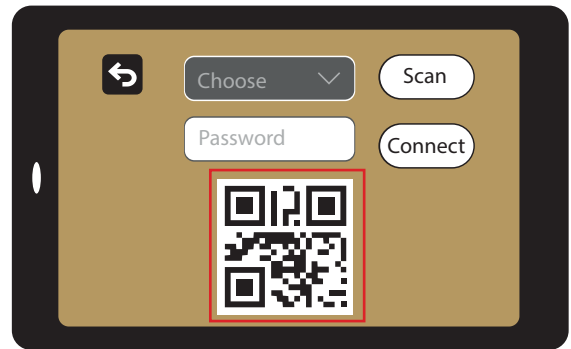
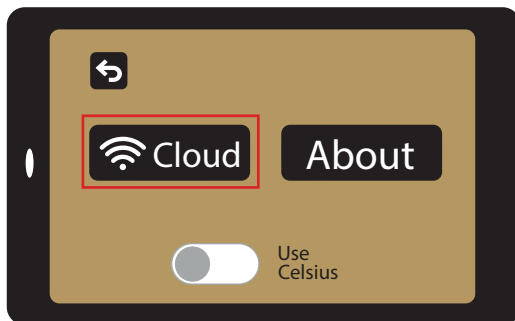
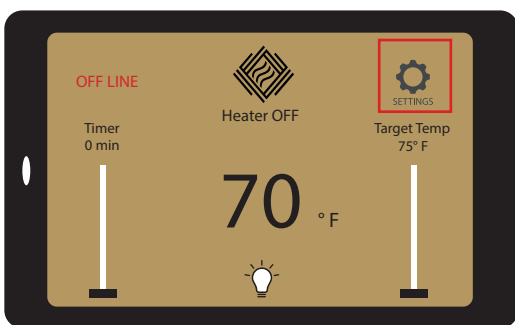

32.7: Once the Sauna ID appears next to the QR code press submit.

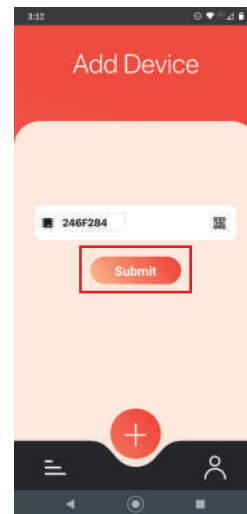

32.8: This will take us to the main screen, click on the grey rectangle.

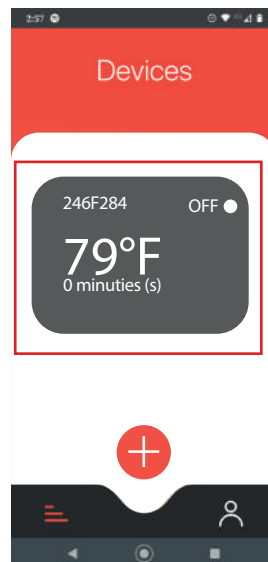

32.9: Regulate the desired temperature with the bar.

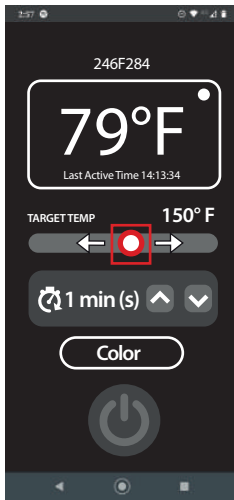

32.10: Press the timer and choose between the preset

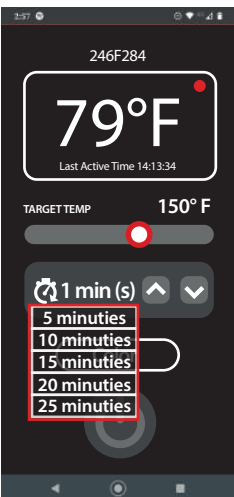
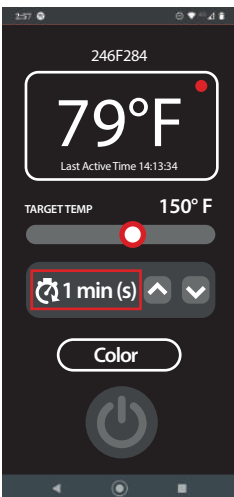

32.11: Or use the arrow buttons.

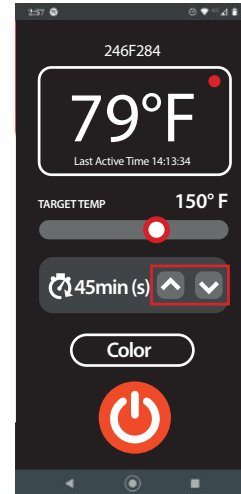

32.12: If you wish to change the LED lighting of your sauna press the Color button.

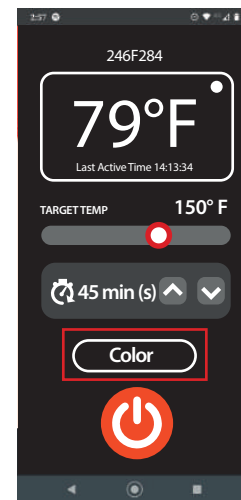

32.13: Slide the bars until you find the desired color and brightness and press OK. NOTE: Lighting colors may vary.



Step 33: Finally, enjoy your Trend Modular Sauna!





A M ~ F I N N
RESIDENTIAL

Custom Backyard Spaces

Your Authorized Am-Finn Dealer in North Carolina

www.CustomBackyardSpaces.com

919-444-8500