



USER MANUAL FOR SPA

PEAKLIFE

/ CONTROL SYSTEMS / KEYPADS / ACCESSORIES /



WARNING

REDUCE THE RISK OF ELECTROCUTION

- Never place an electric appliance within 5 feet of hot tub.

REDUCE THE RISK OF CHILD DROWNING

- Supervise children at all times.
- Attach hot tub cover after each use.

REDUCE THE RISK OF OVERHEATING

- Check with a doctor before use if pregnant, diabetic, in poor health, or under medical care.
- Exit immediately if uncomfortable, dizzy, or sleepy. Hot tub heat can cause hyperthermia and unconsciousness.
- Hot tub heat in conjunction with alcohol, drugs, or medication can cause unconsciousness.

WHEN PREGNANT, measure water temperature before entering.

- Soaking in hot water for long periods can harm your fetus.
- Exit immediately if uncomfortable, dizzy, or sleepy. Hot tub heat can cause hyperthermia and unconsciousness.
- Hot tub heat in conjunction with alcohol, drugs, or medication can cause unconsciousness.

TABLE OF CONTENTS

Introduction	2
Safety instructions	3
Safety instructions - Canada	10
Important safety instructions	13
Basic Functions	14
Connection diagram	
Everest Life	16
Kilimanjaro Life	17
Elbrus Life	18
Atlas Life	19
Mandala Life	20
Teide Life	21
Initial installation	22
Maintenance	26
In line quickstart guide	27
Jet Directions	
Everest Life	31
Kilimanjaro Life	32
Elbrus Life	33
Atlas Life	34
Mandala Life	35
Teide Life	36
User interface	
Smart Touch	37
4 and 1 single button panel	49
Other accessories	
Electric water diverter for use	50
The Heat Pump	51
Smart step manual (optional)	55
Other accessories	
Aquasoul Pro	70
Ozone	72
in.grid	73
in.touch 2	74
Wellis Spa Control	79
Wiring diagram - W3000	98
Breaker setting	102
Power up	103
Common hardware issues	104

INTRODUCTION

Congratulations on your new product!

Outside work and family the enjoyment of quality life and calm moments plays an important role in the life of a 21st century man. An evening bath in the hot tub or tub alone or in company can give you the opportunity to lose track of time and your body and soul can relax. From the world of rationality we get into the world of senses where the cossetting atmosphere of the water provides the perfect conditions for relaxation.

Our design engineers utilized the experiences of the ancient Eastern massage culture and the modern findings of Western hydrotherapy to create hot tubs providing the perfect massage experience.

Develop a peaceful space for relaxation with your product in your home and join the group of the few who seek a positive impact on their environment by establishing internal harmony.

Dive into your hot tub and enjoy the gently flowing water!

Aeware®, Gecko®, and their respective logos are Registered Trademarks of Gecko Alliance Group. in.yt™, in.ye™, in.yj™, in.touch™, in.stream 2™, DJS™, in.k110™, in.k120™, in.k361™, in.k1001™, in.clear™, and their respective logos are Trademarks of Gecko Alliance Group.

All other product or company names that may be mentioned in this publication are tradenames, trademarks or registered trademarks of their respective owners.

IMPORTANT SAFETY INSTRUCTIONS

1. **READ AND FOLLOW ALL INSTRUCTIONS.**
2. **WARNING** – To reduce the risk of injury, do not permit children to use this product unless they are closely supervised at all times.
3. A wire connector is provided on this unit to connect a minimum 8 AWG (8.4 mm²) solid copper conductor between this unit and any metal equipment, metal enclosures of electrical equipment, metal water pipe, or conduit within 5 feet (1.5 m) of the unit.
4. (For cord-connected/convertible units) **DANGER** – Risk of injury.
 - a) Replace damaged cord immediately.
 - b) Do not bury cord.
 - c) Connect to a grounded, grounding type receptacle only.
5. **DANGER** – Risk of Accidental Drowning. Extreme caution must be exercised to prevent unauthorized access by children. To avoid accidents, ensure that children cannot use this hot tub unless they are supervised at all times.
6. **DANGER** – Risk of Injury. The suction fittings in this hot tub are sized to match the specific water flow created by the pump. Should the need arise to replace the suction fittings or the pump, be sure that the flow rates are compatible.
 Never operate hot tub if the suction fittings are broken or missing. Never replace a suction fitting with one rated less than the flow rate marked on the original suction fitting.
7. **DANGER** – Risk of Electric Shock. Install at least 5 feet (1.5 m) from all metal surfaces. As an alternative, a hot tub may be installed within 5 feet of metal surfaces if each metal surface is permanently connected by a minimum 8 AWG (8.4 mm²) solid copper conductor to the wire connector on the terminal box that is provided for this purpose.
8. **DANGER** – Risk of Electric Shock. Do not permit any electric appliance, such as a light, telephone, radio, or television, within 5 feet (1.5 m) of a hot tub.
9. **WARNING** – To reduce the risk of injury:
 - a) The water in a hot tub should never exceed 40°C (104°F). Water temperatures between 38°C (100°F) and 40°C are considered safe for a healthy adult. Lower water temperatures are recommended for young children and when hot tub use exceeds 10 minutes.
 - b) Since excessive water temperatures have a high potential for causing fetal damage during the early months of pregnancy, pregnant or possibly pregnant women should limit hot tub water temperatures to 38°C (100°F).
 - c) Before entering a hot tub, the user should measure the water temperature since the tolerance of water temperature-regulating devices varies.
 - d) The use of alcohol, drugs, or medication before or during hot tub use may lead to unconsciousness with the possibility of drowning.
 - e) Obese persons and persons with a history of heart disease, low or high blood pressure, circulatory system problems, or diabetes should consult a physician before using a hot tub.
 - f) Persons using medication should consult a physician before using a hot tub since some medication may induce drowsiness while other medication may affect heart rate, blood pressure, and circulation.

13. SAVE THESE INSTRUCTIONS.

Audio/video components

- a) "CAUTION – Risk of Electric Shock. Do not leave compartment door open";
- b) "CAUTION – Risk of Electric Shock. Replace components only with identical components"; and
- c) "Do not operate the audio/video controls while inside in the hot tub".
- d) "WARNING – Prevent Electrocutation. Do not connect any auxiliary components (for example cable, additional speakers, headphones, additional audio/video components, etc.) to the system".
- e) These units are not provided with an outdoor antennae; when provided, it should be installed in accordance with Article 810 of the National Electrical Code, ANSI/NFPA 70.
- f) Do not service this product yourself as opening or removing covers may expose you to dangerous voltage or other risk of injury. Refer all servicing to qualified service personnel.
- g) When the power supply connections or power supply cord(s) are damaged; if water is entering the audio/video compartment or any electrical equipment compartment area; if the protective shields or barriers are showing signs of deterioration; or if there are signs of other potential damage to the unit, turn off the unit and refer servicing to a qualified service personnel.
- h) This unit should be subjected to periodic routine maintenance (for example, once every 3 months) to make sure that the unit is operating properly.

FOR YOUR SAFETY PLEASE ALWAYS PERFORM THE FOLLOWING PRECAUTIONS. IF YOU DO NOT FOLLOW THE WARNINGS AND INSTRUCTIONS, ITEMS MAY GET DAMAGED, YOU MAY GET INJURED, OR YOU MAY SUFFER FATAL INJURY. IMPROPER INSTALLATION AND OPERATION INVALIDATES THE WARRANTY. AVOIDING THE RISK TO CHILDREN

- To reduce the risk of injury, lower water temperatures are recommended for young children. Children are especially sensitive to hot water.
- Extreme caution must be exercised to prevent unauthorized access by children. To avoid accidents, ensure that children cannot use a hot tub unless they are supervised at all times.

DO:

- Make sure you always lock the child resistant locks after using the hot tub for your children's safety.
- Test the water temperature with your hand before allowing children to enter the hot tub to be sure that it's comfortable. Children are especially sensitive to hot water.
- Remind children that wet surfaces can be very slippery. Make sure that children are careful when entering or exiting the hot tub.
- Do not allow children to climb onto the hot tub cover.
- Do not allow children to have unsupervised access to the hot tub.

SAFETY INSTRUCTIONS

AVOIDING THE RISK OF ELECTROCUTION



DANGER - RISK OF ELECTROCUTION

Initial safety warnings

- The hot tub must be powered through a residual current device (rCD) with a current release not exceeding 30mA.
- The devices and parts which contain active parts – except those which are powered from protective extra low voltage not exceeding 12V – must be inaccessible from the hot tub.
- Connect only to a grounded source.
- Do not bury the power cord. A buried power cord may result in death, or serious personal injury due to electrocution if direct burial-type cable is not used, or if improper digging occurs.



WARNING

- To reduce the risk of electrical shock, replace a damaged cord immediately. Failure to do so may result in death or serious personal injury due to electrocution.
- Your hot tub must be connected to a Ground Fault Circuit Interrupter (GFCI) for user and equipment protection. To ensure proper operation of this important safety device, test according to the following instructions per electrical configuration.
- **Cord-Connected 115 volt, 20 amp models:** The GFCI is located at the end of the power cord. Before each use, with the unit operating, push the TEST button. The unit should stop operating and the GFCI power indicator will go out. Wait 30 seconds and then reset the GFCI by pushing the RESET button. The GFCI power indicator will turn on, restoring power to the hot tub. If the interrupter does not perform in this manner, there

may be an electrical malfunction and with it, the possibility of an electric shock. Disconnect the power until the problem has been corrected.

- **2x120 volt, permanently connected or converted models:**
- A ground terminal is provided on the terminal block (TB-1, system ground terminal) located inside the control box. To reduce the risk of electric shock, connect this terminal to the grounding terminal of your electrical service or supply panel with a continuous green, insulated copper wire. The wire must be equivalent in size to the circuit conductors supplying the equipment. In addition, a bonding terminal (pressure wire connector) is provided on the outside of the control box for bonding to local ground points. To reduce the risk of electric shock, this connector should be bonded with a No. 8 AWG (8.4 mm²) solid copper wire to any metal ladders, water pipes, or other metal within 5 feet (1.5 m) of the hot tub to comply with local requirements. The means of disconnection must be readily accessible, but must be installed at least 5 feet (1.5 m) from the hot tub.
- Your hot tub is provided with a suitably rated circuit breaker to open all ungrounded supply conductors.
- Your hot tub uses ground fault circuit interrupters in the electrical sub-panel. Before each use of the hot tub and with the unit operating, push the TEST button on each breaker. The switch should click over to the “Trip” position. Wait 30 seconds and reset each GFCI breaker by switching it completely off and then completely on.

The switch should then stay on. If either of the interrupters does not perform in this manner, it is an indication of an electrical malfunction and the possibility of an electric shock. Disconnect the power until the fault has been identified and corrected.

SAFETY INSTRUCTIONS

IMPORTANT: Failure to wait 30 seconds before resetting the GFCI may cause the hot tub's Power Indicator (on the control panel) to blink. If this occurs, repeat the GFCI test procedure.



DANGER - RISK OF ELECTRIC SHOCK

- A wire connector is provided on this unit to connect a minimum 8 AWG (8.4 mm²) solid copper conductor between this unit and any metal equipment, metal enclosures of electrical equipment, metal water pipe, or conduit within 5 feet (1.5 m) of the unit.
- Install at least 5 feet (1.5 m) from all metal surfaces. As an alternative, a hot tub may be installed within 5 feet of metal surfaces if each metal surface is permanently connected by a minimum 8 AWG (8.4 mm²) solid copper conductor to the wire connector on the terminal box that is provided for this purpose.
- Do not permit any electric appliance, such as a light, telephone, radio, or television, within 5 feet (1.5 m) of a hot tub. Failure to maintain a safe distance may result in death, or serious personal injury due to electrocution, if the appliance should fall into the hot tub.
- Install your hot tub in such a way that drainage is away from the electrical compartment and from all electrical components.
- **CAUTION** — Risk of Electric Shock. Do not leave compartment door open
- **CAUTION** — Risk of Electric Shock. Replace components only with identical components
- Do not service this product yourself as opening or removing covers may expose you to dangerous voltage or other risk of injury. Refer all servicing to qualified service personnel.

DO:

- Be sure your hot tub is connected to the power supply correctly - use a licensed electrical contractor.
- Disconnect the hot tub from the power supply before draining the hot tub or servicing the electrical components.
- Test the Ground Fault Circuit Interrupter(s) before each use.
- Do not use the hot tub with the equipment compartment door removed.
- Do not place electrical appliances within 5 feet (1.5m) of the hot tub.
- Do not use an extension cord to connect the hot tub to its power source. The cord may not be properly grounded and the connection is a shock hazard. An extension cord may cause a voltage drop, which will cause overheating of the jet pump motor and motor damage.
- Do not attempt to open the electrical control box. There are no user serviceable parts inside.

RISKS TO AVOID



DANGER - RISK OF INJURY

- To reduce the risk of injury to persons, **DO NOT** remove suction fittings (filter standpipes) located in the filter compartment.
- There is a danger of slipping and falling. Remember that wet surfaces can be very slippery. Take care when entering or exiting the hot tub.
- Never operate hot tub if the suction fittings are broken or missing.
- People with infectious diseases should not use the hot tub.
- Keep any loose articles of clothing, long hair, or hanging jewelry away from rotating jets or other moving components.

SAFETY INSTRUCTIONS

- Water treatment should be carried out with caution. Improperly chemically treated water may cause skin irritation.
- Do not remove any suction sealing.
- Do not operate the hot tub if the suction sealing is broken or missing.
- Keep your clothes and jewelry away from rotating jets and moving parts.
- Effects of overheating: you cannot assess emergency situations, do not feel the temperature, do not feel the need to get out of the hot tub, cannot get out of the hot tub; risk of fetal damage in pregnant women, loss of consciousness, suffocation.
- Do not use the hot tub alone.
- Do not use the hot tub immediately after strenuous sport.

INCREASED SIDE EFFECTS OF MEDICATION

- The use of drugs, alcohol may cause unconsciousness with the possibility of drowning.

HEALTH PROBLEMS AFFECTED BY HOT TUB USE

- Pregnant women should consult a physician before using hot tub.
- Obese persons and persons with a history of heart disease, low or high blood pressure, circulatory system problems, or diabetes should consult a physician before using a hot tub.

AVOIDING THE RISK OF HYPERTHERMIA

Prolonged immersion in hot water can result in HYPERTHERMIA. Hyperthermia occurs when the internal temperature of the body reaches a level several degrees above the normal body temperature of 98.6°F. The symptoms of hyperthermia include an increase in the internal temperature of the body, dizziness, lethargy, drowsiness, and fainting. The effects of

hyperthermia include failure to perceive heat; failure to recognize the need to exit hot tub; unawareness of impending hazard; fetal damage in pregnant women; physical inability to exit the hot tub; and unconsciousness resulting in the danger of drowning.



WARNING

The use of alcohol, drugs, or medication before or during hot tub use may lead to unconsciousness with the possibility of drowning.

TO REDUCE THE RISK OF INJURY

- The water in a hot tub should never exceed 40°C (104°F). Water temperatures between 38°C (100°F) and 40°C are considered safe for a healthy adult. Lower water temperatures are recommended for young children and when hot tub use exceeds 10 minutes. Extended use can cause hyperthermia.
- Since excessive water temperatures have a high potential for causing fetal damage during the early months of pregnancy, pregnant or possibly pregnant women should limit hot tub water temperatures to 38°C (100°F).
- Pregnant or possibly pregnant women should limit hot tub water temperatures to 100°F (36°C). Failure to do so may result in permanent injury to your baby.
- Do not use hot tub immediately following strenuous exercise.
- Obese persons and persons with a history of heart disease, low or high blood pressure, circulatory system problems, or diabetes should consult a physician before using a hot tub.

SAFETY INSTRUCTIONS

AVOIDING THE RISK OF SKIN BURNS

- Before entering a hot tub, the user should measure the water temperature since the tolerance of water temperature-regulating devices varies.
- To reduce the risk of injury, before entering a hot tub the user should measure the water temperature with an accurate thermometer.
- Test the water with your hand before entering the hot tub to be sure it's comfortable.

PRODUCT SAFETY AND MAINTENANCE

For units intended for use in other than single-family dwellings, a clearly labeled emergency switch must be provided as part of the installation. The switch must be readily accessible to the occupants and must be installed at least 5 feet (1.52 m) away, adjacent to, and within sight of, the unit.

When the hot tub is not in use, cover the hot tub with the cover to prevent ultraviolet radiation causing damage to the product.

Do not remove any suction sealing. Do not operate the hot tub if the suction sealing is broken or missing.

Keep your clothes and jewelry away from rotating jets and moving parts.

Test the residual current device before use.

Disconnect the hot tub from the power supply before servicing its electrical parts. (This operation can only be performed by qualified professionals).

It is strictly prohibited to use the hot tub in a not completely assembled state (e.g. detached side panel)

Chemical treatment of water can only be performed by persons under the age of 18 under parental supervision.

Maintenance can only be performed by trained professionals.

The user should check the electrical wiring every 3 months. It is required to perform a check by a professional every 3 years.

Mains, fuses, and circuit breakers may be activated because of power outages.

Installation and wiring of the hot tub, replacement of power cord, and any repairs must be performed by qualified professionals.

It is required to build in an isolating device to the fixed wiring.

PLUG'N PLAY SAFETY WARNINGS BEYOND THE PREVIOUS WARNINGS, PLEASE ALSO PAY ATTENTION TO THE UNDERMENTIONED ONES.

ATTENTION! *The electrical receptacle must be located at least 2.5 meters from the hot tub so that bathers in a sitting position cannot reach it from the water. The plug can only be connected to a receptacle equipped with 2.5mm 2 diameter cables.*

ATTENTION! RISK OF ELECTRIC SHOCK. *The connector with residual current device must be inspected before every use.*

ATTENTION! *Only place the RCD plug in a receptacle equipped with RCD.*

ATTENTION! *Before you insert the plug into the socket ensure that the current of the socket and the fixed wiring is appropriate for the properties of the hot tub.*

The hot tub must be equipped with an isolation transformer or powered through a residual current device with a release current not exceeding 30mA.

This product is equipped with a ground fault circuit breaker (GFCI) in the connector. GFCI must be tested before each use.

If the power cable is damaged, it must immediately be replaced by the manufacturer or a service professional in order to minimize danger.

SAFETY INSTRUCTIONS

To minimize the risk of electric shock do not use extension leads to connect the product to the power supply.

Ensure that the receptacle is properly located.

Parts of the equipment cannot be placed above the hot tub during usage.

Parts under electrical power – except those operating with voltage not exceeding 12V - must be inaccessible for persons in the hot tub. The grounded device must be connected to a fixed socket with fixed wiring. Electrical parts – except remote controllers – must be positioned so as not to fall into the hot tub.

The electrical installation must meet the local standard requirements.

To avoid electric shock do not use the hot tub in rain.

Water attracts children. Always place and lock the cover on the hot tub after each usage.

Do not bury cables into the ground! Place the cables so that lawnmowers, trimmers, and similar devices will not reach them.

Do not force push the control panel up nor down and do not place heavy objects on it after installation.

Keep pets away from the hot tub to avoid damage.

Do not use the device if there is the slightest chance of water in the hot tub being frozen.

Only use accessories approved by us. The use of accessories not approved by us may void the warranty.

Choking hazard. Particular attention need to be paid to children during usage. To avoid accidents only allow children to use this hot tub under adult supervision.

To prevent damage to the pump the hot tub can only be operated if it has been filled with water.

If you feel uncomfortably or sleepy, leave the hot tub immediately.

Never add water to the chemicals. Always be cautious when adding chemicals to the hot tub water to avoid inhaling vapors and possible effects of inhaling undiluted chemicals and splatters.

Only place the hot tub on a surface that can support its weight.

Inspect the unit before use. contact the service provider stated in this manual if any of the parts were damaged or missing upon purchase. Ensure that the parts of the unit are those which you intended to buy.

In.clear safety warnings

Beyond the previous warnings, please also pay attention to the undermentioned ones read this manual carefully, always follow its instructions, and retain it. This manual contains important information about the installation, operation, and safety recommendations of the in.clear unit. Safe installation and usage is your responsibility.

The in.clear unit must be connected to a network protected by a ground fault circuit interrupter (GFCI) of the maximal nominal fault current value of 30mA.

Ensure that the entire power supply is turned off before the in.clear unit is installed.

If the power cord is damaged, it must be replaced by the manufacturer, an authorized service provider, or qualified professionals to avoid emergencies.

Always use a proper electric cable for supply of current to the in.clear unit.

When installing the in.clear Automatic Bromine Generator local and international electrical regulations must be complied with.

Clean or replace the filter cartridge at regular intervals, otherwise part of the bromine produced by the in.clear unit will be consumed by oxidation of contamination accumulated in the filter.

DO NOT pour any other chemicals into the hot tub than the recommended sodium bromide.
DO NOT use any ozone or UV disinfectant.

Operating the in.clear unit on lower sodium bromide level shortens the life of the cells. Keeping sodium bromide and bromine levels above the recommended level may lead to corrosion of the hot tub components and cause damage to the hot tub accessories.

Do not open the in.clear unit; it does not contain serviceable parts

Product disposal: the in.clear unit must be disposed of in accordance with local disposal regulations in force.

This device is not intended for use by persons (nor children) with limited physical, sensory, or mental capabilities except if these persons have received appropriate instruction on use of the device from the person responsible for their safety.

The in.clear unit cannot be applied to in-ground sunken hot tubs as it may affect materials used in the construction.

The shut-off device must have fixed wiring in accordance with the cabling regulations.

Showering is compulsory before each hot tub use.

The user is responsible for regular monitoring of the hot tub water to ensure that enough bromine is available to reach the appropriate cleaning level. Intensive hot tub use may require higher bromine intake to always maintain appropriate bromine level.

Always check the expiry date of the test kit, because after this date the test results may be inaccurate.

For proper disinfection hot tubs must periodically be completely drained. The advised time period between full drains given in days is calculated by dividing the capacity of the hot tub in liters by the tenfold of the average daily users.

The in.clear unit is applicable for indoor hot tubs, but NOT for swimming pools.

THIS UNIT SHOULD BE SUBJECTED TO PERIODIC ROUTINE MAINTENANCE (FOR EXAMPLE, ONCE EVERY 3 MONTHS) TO MAKE SURE THAT THE UNIT IS OPERATING PROPERLY.

SAVE THESE INSTRUCTIONS

WARNING: CHILDREN SHOULD NOT USE HOT TUBS OR HOT TUBS WITHOUT ADULT SUPERVISION

AVERTISSEMENT : NE PAS LAISSER LES ENFANTS UTILISER UNE CUVE DE RELAXATION SANS SURVEILLANCE

WARNING: DO NOT USE HOT TUBS OR HOT TUBS UNLESS ALL SUCTION GUARDS ARE INSTALLED TO PREVENT BODY AND HAIR ENTRAPMENT

AVERTISSEMENT : POUR ÉVITER QUE LES CHEVEUX OU UNE PARTIE DU CORPS PUISSENT ÊTRE ASPIRÉS, NE PAS UTILISER UNE CUVE DE RELAXATION SI LES GRILLES DE PRISE D'ASPIRATION NE SONT PAS TOUTES EN PLACE

WARNING: PEOPLE USING MEDICATIONS AND/OR HAVING AN ADVERSE MEDICAL HISTORY SHOULD CONSULT A PHYSICIAN BEFORE USING A HOT TUB

AVERTISSEMENT : LES PERSONNES QUI PRENNENT DES MÉDICAMENTS ET (OU) ONT DES PROBLÈMES DE SANTÉ DEVRAIENT CONSULTER UN MÉDECIN AVANT D'UTILISER UNE CUVE DE RELAXATION

WARNING: PEOPLE WITH INFECTIOUS DISEASES SHOULD NOT USE A HOT TUB

AVERTISSEMENT : LES PERSONNES ATTEINTES DE MALADIES INFEC-

SAFETY INSTRUCTIONS - CANADA

TIEUSES NE DEVRAIENT PAS UTILISER UNE CUVE DE RELAXATION

WARNING: TO AVOID INJURY, EXERCISE CARE WHEN ENTERING OR EXITING THE HOT TUB

AVERTISSEMENT : POUR ÉVITER DES BLESSURES, USER DE PRUDENCE EN ENTRANT DANS UNE CUVE DE RELAXATION ET EN SORTANT

WARNING: DO NOT USE DRUGS OR ALCOHOL BEFORE OR DURING THE USE OF A HOT TUB TO AVOID UNCONSCIOUSNESS AND POSSIBLE DROWNING

AVERTISSEMENT : POUR ÉVITER L'ÉVANOUISSEMENT ET LA NOYADE ÉVENTUELLE, NE PRENDRE NI DROGUE NI ALCOOL AVANT D'UTILISER UNE CUVE DE RELAXATION NI QUAND ON S'Y TROUVE

WARNING: PREGNANT OR POSSIBLY PREGNANT WOMEN SHOULD CONSULT A PHYSICIAN BEFORE USING A HOT TUB

AVERTISSEMENT : LES FEMMES ENCEINTES, QUE LEUR GROSSESSE SOIT CONFIRMÉE OU NON, DEVRAIENT CONSULTER UN MÉDECIN AVANT D'UTILISER UNE CUVE DE RELAXATION

WARNING: WATER TEMPERATURE IN EXCESS OF 38 °C CAN BE INJURIOUS TO YOUR HEALTH

AVERTISSEMENT : IL PEUT ÊTRE DANGEREUX POUR LA SANTÉ DE SE PLONGER DANS DE L'EAU À PLUS DE 38 °C

WARNING: BEFORE ENTERING THE HOT TUB, MEASURE THE WATER TEMPERATURE WITH AN ACCURATE THERMOMETER

AVERTISSEMENT : AVANT D'UTILISER UNE CUVE DE RELAXATION, MESURER LA TEMPÉRATURE

DE L'EAU À L'AIDE D'UN THERMOMÈTRE PRÉCIS

WARNING: DO NOT USE A HOT TUB IMMEDIATELY FOLLOWING STRENUOUS EXERCISE

AVERTISSEMENT : NE PAS UTILISER UNE CUVE DE RELAXATION IMMÉDIATEMENT APRÈS UN EXERCICE FATIGANT

WARNING: PROLONGED IMMERSION IN A HOT TUB CAN BE INJURIOUS TO YOUR HEALTH

AVERTISSEMENT : L'UTILISATION PROLONGÉE D'UNE CUVE DE RELAXATION PEUT ÊTRE DANGEREUSE POUR LA SANTÉ

WARNING: DO NOT PERMIT ELECTRIC APPLIANCES (SUCH AS A LIGHT, TELEPHONE, RADIO, OR TELEVISION) WITHIN 1.5 M OF THIS SPA OR HOT TUB

AVERTISSEMENT : NE PAS PLACER D'APPAREIL ÉLECTRIQUE (LUMINAIRE, TÉLÉPHONE, RADIO, TÉLÉVISEUR, ETC) À MOINS DE 1.5 M DE CETTE CUVE DE RELAXATION

CAUTION : MAINTAIN WATER CHEMISTRY IN ACCORDANCE WITH MANUFACTURER'S INSTRUCTIONS

ATTENTION: LA TENEUR DE L'EAU EN MATIÈRES DISSOUTES DOIT ÊTRE CONFORME AUX DIRECTIVES DU FABRICANT.

WARNING: THE USE OF ALCOHOL OR DRUGS CAN GREATLY INCREASE THE RISK OF FATAL HYPERTHERMIA IN HOT TUBS AND SPAS

LA CONSOMMATION D'ALCOOL OU DE DROGUE AUGMENTE CONSIDÉRABLEMENT LES RISQUES D'HYPERTHERMIE MORTELLE DANS UNE CUVE DE RELAXATION.

SAFETY INSTRUCTIONS - CANADA

WARNING: RISK OF ACCIDENTAL DROWNING. EXTREME CAUTION MUST BE EXERCISED TO PREVENT UNAUTHORIZED ACCESS. ENSURE THAT CHILDREN CANNOT USE THIS PRODUCT UNLESS THEY ARE SUPERVISED AT ALL TIMES

AVERTISSEMENT : RISQUE DE NOYADE. PRENDRE TOUTES LES PRÉCAUTIONS NÉCESSAIRES POUR INTERDIRE L'ACCÈS AUX PERSONNES NON AUTORISÉES. S'ASSURER QUE LES ENFANTS NE PUISSENT PAS UTILISER CE PRODUIT SANS SURVEILLANCE CONSTANTE

WARNING: RISK OF ACCIDENTAL DROWNING. THE USE OF ALCOHOLIC BEVERAGES OR DRUGS BEFORE OR DURING HOT TUB USE CAN LEAD TO UNCONSCIOUSNESS WITH THE POSSIBILITY OF DROWNING

AVERTISSEMENT : RISQUE DE NOYADE. TOUTE PERSONNE QUI PREND DE LA DROGUE OU DE L'ALCOOL AVANT D'UTILISER UNE CUVE DE RELAXATION OU PENDANT QU'ELLE S'Y TROUVE RISQUE L'ÉVAUOISEMENT ET LA NOYADE

WARNING: RISK OF ACCIDENTAL DROWNING DUE TO HYPERTHER-

MIA. CONSULT THE INSTRUCTIONS PROVIDED WITH THIS UNIT FOR A DESCRIPTION OF THE CAUSES, SYMPTOMS, AND EFFECTS OF HYPERTHERMIA

AVERTISSEMENT : RISQUE DE NOYADE PAR SUITE D'HYPERTHERMIE. LIRE LA NOTICE QUI ACCOMPAGNE

CET APPAREIL; ELLE DÉCRIT LES CAUSES, LES SYMPTÔMES ET LES EFFETS DE L'HYPERTHERMIE

WARNING: RISK OF ELECTRIC SHOCK. DO NOT PERMIT ANY ELECTRIC APPLIANCE (SUCH AS A LIGHT, TELEPHONE, RADIO, OR TELEVISION) WITHIN 1.5 M OF A HOT TUB

AVERTISSEMENT : DANGER D'ÉLECTROCUTION. NE PAS PLACER D'APPAREIL ÉLECTRIQUE (LUMINAIRE, TÉLÉPHONE, RADIO, TÉLÉVISEUR, ETC) À MOINS DE 1.5 M DE CETTE CUVE DE RELAXATION

WARNING: THIS MARKING SHALL BE REMOVED BY THE END USER OF THIS PRODUCT ONLY

AVERTISSEMENT : SEUL L'UTILISATEUR DE CE PRODUIT PEUT ENLEVER CE MARQUAGE.

IMPORTANT SAFETY INSTRUCTIONS

When using this electrical equipment, basic safety precautions should always be followed, including the following:

A) READ AND FOLLOW ALL INSTRUCTIONS.

B) A GREEN COLORED TERMINAL OR A TERMINAL MARKED G, GR, GROUND, GROUNDING, OR THE ⊕ SYMBOL IS LOCATED INSIDE THE SUPPLY TERMINAL BOX OR COMPARTMENT. TO REDUCE THE RISK OF ELECTRIC SHOCK, THIS TERMINAL MUST BE CONNECTED TO THE GROUNDING MEANS PROVIDED IN THE ELECTRIC SUPPLY SERVICE PANEL WITH A CONTINUOUS COPPER WIRE EQUIVALENT IN SIZE TO THE CIRCUIT CONDUCTORS SUPPLYING THIS EQUIPMENT.

C) AT LEAST TWO LUGS MARKED “BONDING LUGS” ARE PROVIDED ON THE EXTERNAL SURFACE OR ON THE INSIDE OF THE SUPPLY TERMINAL BOX OR COMPARTMENT. TO REDUCE THE RISK OF ELECTRIC SHOCK, CONNECT THE LOCAL COMMON BONDING GRID IN THE AREA OF THE HOT TUB OR SPA TO THESE TERMINALS WITH AN INSULATED OR BARE COPPER CONDUCTOR NOT SMALLER THAN NO. 6 AWG.

D) ALL FIELD-INSTALLED METAL COMPONENTS SUCH AS RAILS, LADDERS, DRAINS, OR OTHER SIMILAR HARDWARE WITHIN 3 M OF THE SPA OR HOT TUB SHALL BE BONDED TO THE EQUIPMENT GROUNDING BUS

WITH COPPER CONDUCTORS NOT SMALLER THAN NO. 6 AWG.

E) SAVE THESE INSTRUCTIONS.

F) DISTINGUISHING BETWEEN P&P AND NON P&P INSTALLATION:

IT'S IMPORTANT TO DIFFERENTIATE BETWEEN PLUG & PLAY (P&P) AND NON PLUG & PLAY (NON P&P) INSTALLATION METHODS AS THEY IMPACT THE SETUP OF THE HOT TUB, PARTICULARLY REGARDING THE SECURING OF THE HOT TUB AND THE PLACEMENT OF WIRES.

NON P&P INSTALLATION:

IN CASES WHERE THE HOT TUB IS NOT SET UP AS A PLUG & PLAY SYSTEM, IT IS NECESSARY TO SECURE THE HOT TUB TO PREVENT THE POWER CORD FROM MECHANICAL DAMAGE. THIS IS PARTICULARLY CRUCIAL IF THE HOT TUB IS NOT SUNK INTO ANY LEVEL.

THE MOVEMENT OF THE HOT TUB CONSTITUTES A REINSTALL IN EVERY CASE, PLEASE ENSURE THAT THE HOT TUB CANNOT MOVE.

BASIC FUNCTIONS

Keypads: The keypads make it possible to control and set up the spa. Available basic functions: pump(s), light and temperature control. (For more information see the details later)

Valves

Diverter: Some spa are equipped with water diverter(s) that allows you to direct the waterflow to various sections of the spa. The valve has three basic positions By turning the lever all the way to the left position will divert the water section A of the spa. By turning the lever all the way to the right will shut off section A and divert the water to section B and by moving the lever to the middle between A & B will divert the water to both A & B sections

Waterfall diverter: Some spas are equipped with a waterfall diverter which will turn the waterfalls/fountains either on or off

Air regulators: You can use it by turning the lever counter-clockwise, will open the Air Regulator to allow air to mix with the water to create more pressure from the jets. Turning the lever to the left will close the valve not allowing air to mix with the water for the jets. These air regulators should remain closed when the spa is not in use to save energy.

Speakers (Optional): If your spa is equipped with an audio system, you can connect via Bluetooth and help your relaxing with your favourite music. (AquaSoul™ pin: 5555)

Filter house: Part of the recirculating system, it holds the paper filter.

Fountain: Some spas are equipped with fountains or waterfalls. If you open the waterfall diverter, the water will flow through the fountains or waterfalls.

Jets: There are 2 sizes of normal jets: 3" and 5".

Infinity jet: The infinity jet makes the massage experience even more enjoyable by massaging a larger portion of the body and doesn't only move up and down, it draws an infinite figure eight as it turns.

Circulation jet: the new circulation jet has been designed to have 3 zones, where 2 zones are pointed downwards to stir up the sand and dirt from the bottom of the hot tub.

Suction: The pumps suck the water through this element. Never block it, and keep your body and hair away from these units.

Head rests



Keypads



Diverter, Air regulator, On/off valve



Speaker cover



Filter house



Fountain



Jets (Infinity, 5"-direct, 3"-direct)



Circulation jet



Suction



Lights



Instructions for Reading the Code on the Data Card:

Locate the data card on your spa, usually situated beneath the side panel, typically on the same side as the control panel. Utilize the table provided on the following page to decipher the internal code to determine the spa specification.

Example of data card:

MANUFACTURER / HERSTELLER / VÝROBKA / FABRICANT / GYÁRTÓ	Wellis®
INTERNAL ORD. NR. / BELSŐ MEGR. SZ.	E414141
MODEL	Málaga Life
TYPE	WM10*GCECBD2****HIMNE**WNN
SERIAL NUMBER / SERIAN NUMMER / VÝROBNÉ ČÍSLO / UMERO DE SERUE/ GYÁRTÁSI SZÁM	WM00541-41
Date of production / Herstellungsdatum / Ciklus dátuma	240314
max. POWER / LEISTUNG / TELJESÍTMÉNY	8 kW
CONTROL PANEL / BEDIENUNGSTASTE / KEZELŐ	DN.K500
Wellis Magyarország Zrt. Hungary-2371, Dabas. Mátzalkai út 1rcv.: 0417	 400V 3N~

CONNECTION DIAGRAM

EVEREST LIFE

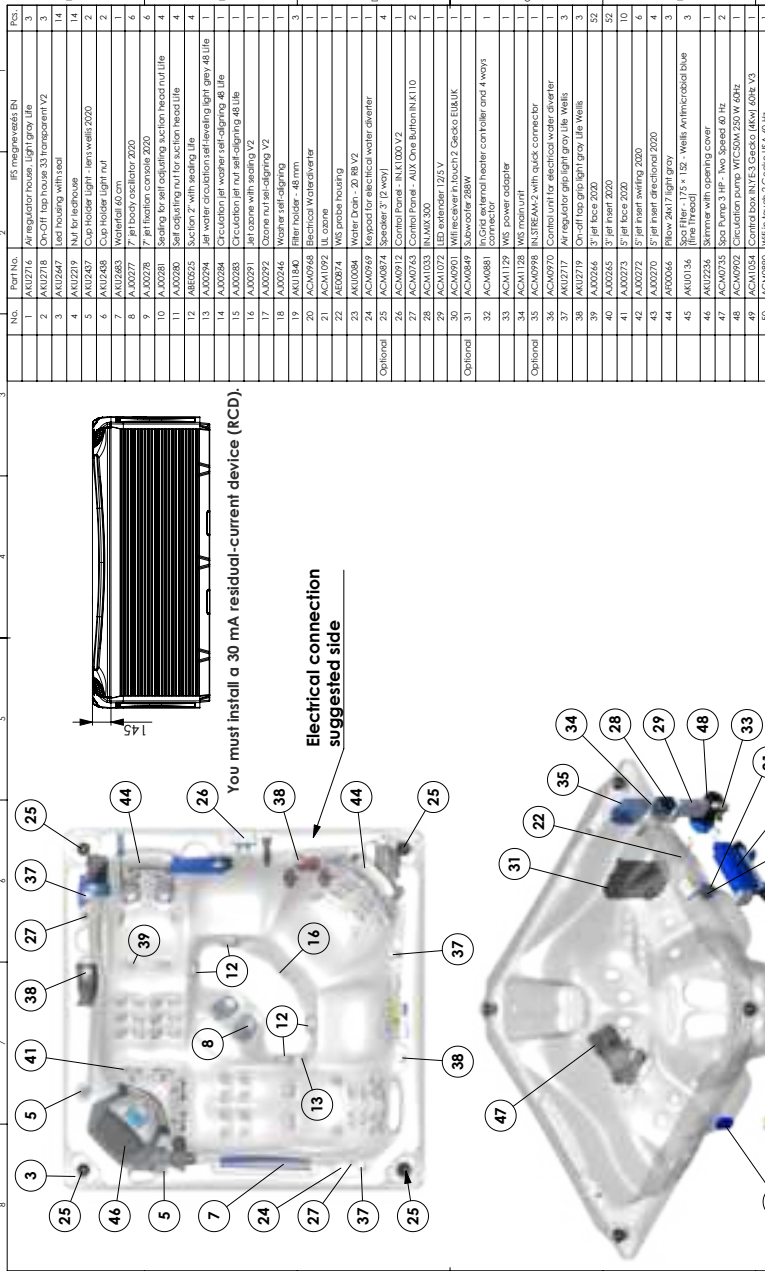

No.	Part No.	Part Name	Qty
1	AKU2716	IFC megareads BN	1
2	AKU2718	Air regulator house, Light grey, Life	3
3	AKU2718	On-Off tap house, 33 Transparent V2	3
4	AKU2647	Leak housing, with seal	14
5	AKU2719	Nut for electrode	14
6	AKU2647	Cup Holder, Light grey, Wellis 2020	2
7	AKU2653	Waterfall 40 cm	1
8	AKU2653	Waterfall 40 cm	1
9	AKU2653	Waterfall 40 cm	1
10	AKU2653	Waterfall 40 cm	1
11	AKU2653	Waterfall 40 cm	1
12	AKU2653	Waterfall 40 cm	1
13	AKU2653	Waterfall 40 cm	1
14	AKU2653	Waterfall 40 cm	1
15	AKU2653	Waterfall 40 cm	1
16	AKU2653	Waterfall 40 cm	1
17	AKU2653	Waterfall 40 cm	1
18	AKU2653	Waterfall 40 cm	1
19	AKU2653	Waterfall 40 cm	1
20	AKU2653	Waterfall 40 cm	1
21	AKU2653	Waterfall 40 cm	1
22	AKU2653	Waterfall 40 cm	1
23	AKU2653	Waterfall 40 cm	1
24	AKU2653	Waterfall 40 cm	1
25	AKU2653	Waterfall 40 cm	1
26	AKU2653	Waterfall 40 cm	1
27	AKU2653	Waterfall 40 cm	1
28	AKU2653	Waterfall 40 cm	1
29	AKU2653	Waterfall 40 cm	1
30	AKU2653	Waterfall 40 cm	1
31	AKU2653	Waterfall 40 cm	1
32	AKU2653	Waterfall 40 cm	1
33	AKU2653	Waterfall 40 cm	1
34	AKU2653	Waterfall 40 cm	1
35	AKU2653	Waterfall 40 cm	1
36	AKU2653	Waterfall 40 cm	1
37	AKU2653	Waterfall 40 cm	1
38	AKU2653	Waterfall 40 cm	1
39	AKU2653	Waterfall 40 cm	1
40	AKU2653	Waterfall 40 cm	1
41	AKU2653	Waterfall 40 cm	1
42	AKU2653	Waterfall 40 cm	1
43	AKU2653	Waterfall 40 cm	1
44	AKU2653	Waterfall 40 cm	1
45	AKU2653	Waterfall 40 cm	1
46	AKU2653	Waterfall 40 cm	1
47	AKU2653	Waterfall 40 cm	1
48	AKU2653	Waterfall 40 cm	1
49	AKU2653	Waterfall 40 cm	1
50	AKU2653	Waterfall 40 cm	1

Product family: **WellisUSA LineaPeelLife**

Sheet name: **Everest Life, USA**

File name: **FJ_WM00776_ENG_Everest Life, USA, incidence**

Dimension SPA: **238x232x300x50 mm** | Unit Et. (ms): **240 V - 30A - 60Hz** | O.P.E.L. needs: **240V - 50A - 60Hz**

Weight of the SPA: **4.52 Kg** | Rating: **2370/380 USA** | Control box: **GENCO FE-3 K1000**

Rim height: **145 mm** | Approved by: **Redi Tunes** | Number: **WM00776**

Created: **2024_04_12** | Drawer: **ms.tamas - 2024_04_11_10:28:27** | AS | M150 | page 1 / 2

CONNECTION DIAGRAM

KILIMANJARO LIFE

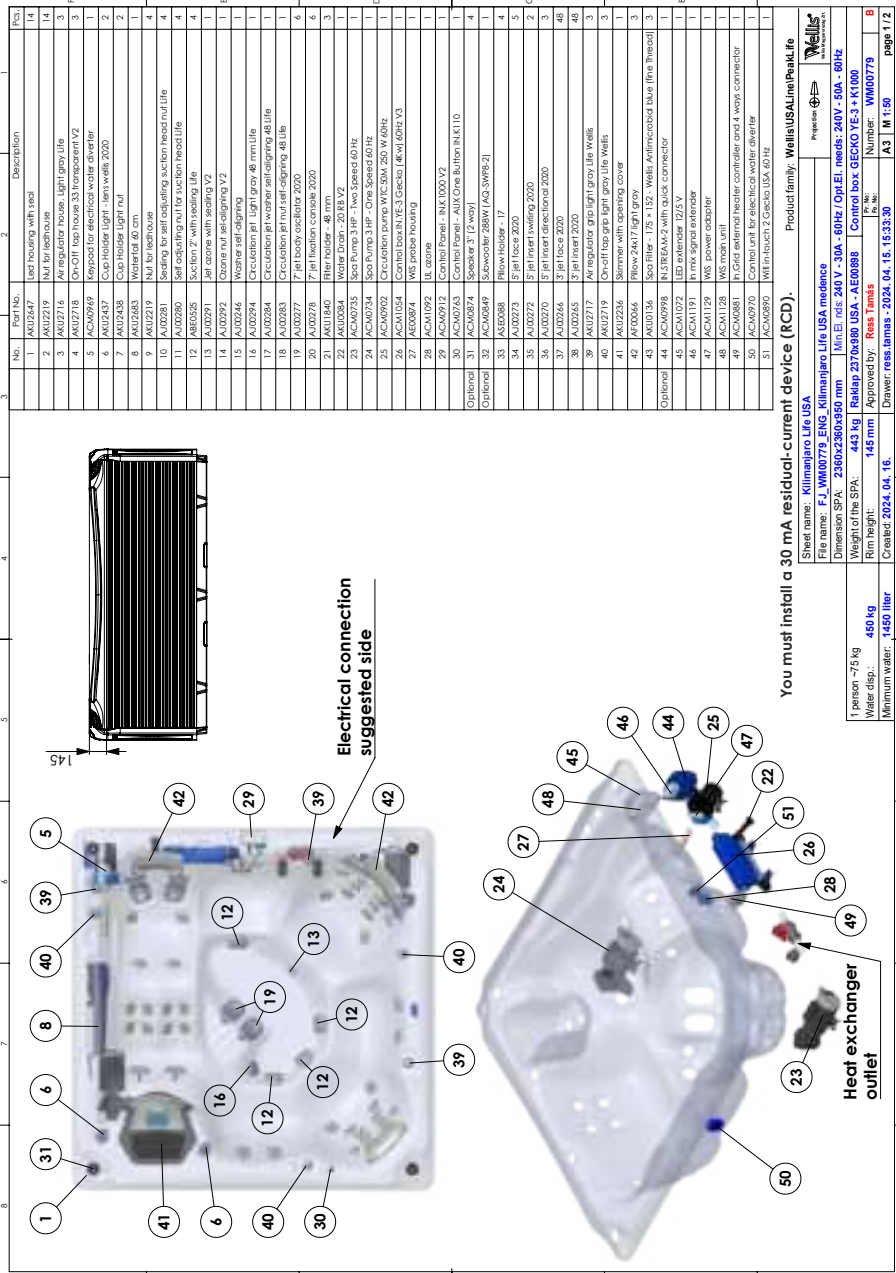

CONNECTION DIAGRAM

ELBRUS LIFE

No.	Part No.	Description	Pic.
1	AKU1893	On-Off tap house 33 transparent V2	3
2	AKU1892	AF Regulator - house led light V2	5
3	AKU2447	Light housing with seal	6
4	AKU2219	Nut for neckhouse	6
5	AKU2402	Process mixer with seal, life	2
6	AKU2403	Process mixer with seal, life	2
7	AKU2438	On/Off heater light up in wells 2020	2
8	AKU2680	Barbed for snap headlife	10
9	AKU2277	7" jet body oscillator 2020	4
10	AKU2278	7" jet fixation console 2020	4
11	ABE0265	Suction 2" with sealing life	3
12	AKU2971	jet ozone with sealing V2	1
13	AKU2972	Ozone nut self-aligning V2	1
14	AKU2946	Water self-aligning	1
15	AKU2982	jet water circulation self-aligning medium gray for life	1
16	AKU1840	Filter holder - 48mm	3
17	AKU1841	Filter - 48mm	3
18	AKU0735	Spa PUMP LIFE - Spa Spaone 60 Hz	1
19	AKU0734	Spa Pump 3 HP - One Spaone 60 Hz	1
20	AKU0902	Circulation pump WFC50W 250 W 60Hz	1
21	AKM1092	ILL ozone	1
22	AKM1054	Control box IN.VE.3, Gecko (fwd) 60Hz V3	1
23	AKU0969	Keypad for electrical water diverter	1
24	AKU0912	Control Panel - IN.JK1000 V2	1
Optional 25	AKU0874	Separator 3" 2-way	4
Optional 26	AKU0978	2" BEE004Z with quick connector	1
Optional 27	AKU0979	2" BEE004Z with quick connector	1
28	AKU0980	Wiring harness 2" Gecko USA 60 Hz	1
29	AKU0881	In.CIG extended heater controller and works connector	1
30	AKM0763	Control Panel - AUX One Multion IN.K110	1
31	AKM1191	In rx signal extender	1
32	AKM1128	WS, power adaptor	1
33	AKM1129	WS, power adaptor	1
34	AKU0970	Control unit for electrical water diverter	1
35	AKU2219	On-Off tap grey light grey life wells	2
36	AKU2217	jet respiratory gas light grey life wells	6
37	AKU2408	jet respiratory gas light grey life wells	6
38	AKU2406	jet respiratory gas light grey life wells	6
39	AKU2225	5" jet face 2020	46
40	AKU2272	5" jet face 2020	11
41	AKU2270	5" jet insert swirling 2020	5
42	AKU2256	5" jet insert directional 2020	6
43	AKU0066	Skimmer with opening cover	1
44	AKU0849	Flow 2x417 light gray	1
Optional 45	ABE0506	Subwater 28kW (A3-3W18-2)	1
Optional 46	ABE0540	Ball valve 48	1
47	ABE0308	Tea 48-32	2
48	ABE0308	Tea 48-32	2

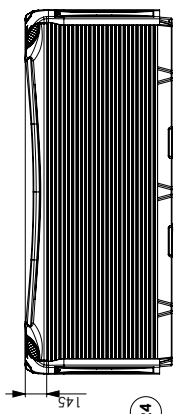

Electrical connection suggested side

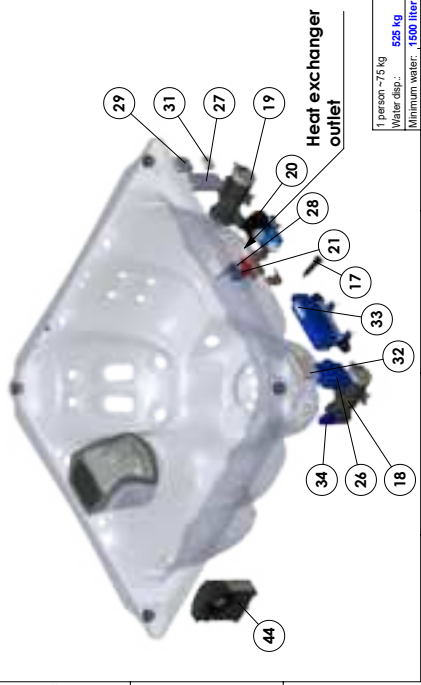
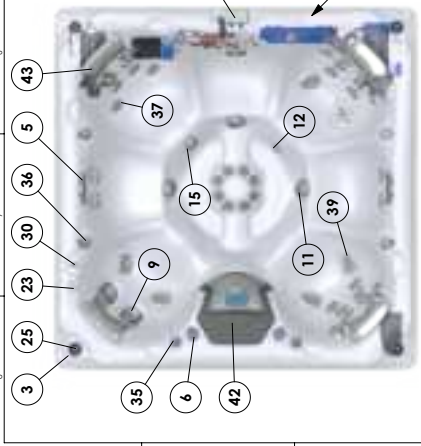

You must install a 30 mA residual-current device (RCD).

Sheet name:	Elbrus Life USA	Product family:	WellsUSA LifePackLife
File name:	F:\WB00780-ENG-Elbrus Life USA-melange		
Dimension SPA:	2380x2380x950 mm	Min. EI:	res: 240 V - 30A - 60Hz / OPEL: needs: 240V - 50A - 60Hz
Weight of the SPA:	452 kg	Package:	2370x950 USA - AEO0886
Rim height:	145 mm	Approved by:	RES Tanks
Created:	2024.04.16	Drawer:	res.tamas - 2024.04.15 - 15:20:21
		Number:	WB00780
		Page:	1/2

1 person - 75 kg
Water disp... 525 kg
Minimum water - 1500 liter

CONNECTION DIAGRAM

ATLAS LIFE

No.	Part No.	Description	Pic.
1	AK102116	Air regulator house, light gray, life	4
2	AK102118	On-Off, tap house, 33 transparent V2	2
3	AK102683	Water filter, 60 cm	1
4	AK102119	Nut for tap house	1
5	AK00307	Flow limiting brass life	6
6	AK102647	Lock housing with seal	2
7	AK102119	Nut for tap house	2
8	AK102119	Nut for tap house	2
9	AK102119	Nut for tap house	2
10	AK102119	Nut for tap house	2
11	AK102681	Sealing for self-cleaning suction head nut, life	4
12	ABE5255	Section 2 with sealing life	4
13	AJ00291	Jet ozone with sealing V2	1
14	AJ00292	Chamé nut self-cleaning V2	1
15	AJ00246	Washer self-cleaning	1
16	AJ00294	Circulation jet, light gray, 48 mm, life	1
17	AJ00285	Circulation jet, nut self-cleaning, 48 life	1
18	AJ00284	Circulation jet, washer self-cleaning, 48 life	1
19	AK10084	Water Drain - 20.98, V2	1
20	AK10082	Circulation pumps, 4PCS, 30x2.95 V, 60Hz	1
21	AK10083	Circulation pumps, 4PCS, 30x2.95 V, 60Hz	1
22	AK100732	Spce Pump 2 140cm - One Speed 60 Hz	1
23	AK09362	MS probe housing	1
24	AK10068	Electrica Water diverter	1
25	AK11022	UL ozone	1
26	AK10054	Control box, IN V.E.S, Cecotec (40W) 60Hz V3	1
27	AK10072	Speaker, grill life	2
28	AK10074	Speaker, 3" (2, woo)	2
29	AK10049	Shower, 288W	1
30	AK10098	INSTREAM2 with cable, connector	1
31	AK10072	LED extender, 125V	1
32	AK11191	Maximize detector	1
33	AK11191	Maximize detector	1
34	AK11128	MS, probe, 60Hz	1
35	AK10269	Keypad for electrical water diverter	1
36	AK100912	Control Panel - IN A1000, V2	1
37	AK10090	WiFi-in-Robot 2, Cecotec USA, 60 Hz	1
38	AK10070	Control unit for electrical water diverter	1
39	AJ00273	5" jet, face 2000	10
40	AJ00271	5" jet, front spinning 2000	2
41	AJ00272	5" jet, front spinning 2000	8
42	AJ00266	5" jet, face 2000	29
43	AJ00265	5" jet, face 2000	29
44	AK0324	Panel, 480x240, gray	2
45	AK12235	Schermes with covering, grid	1
46	AK10136	Spce filter - 17.5 x 152 - Walls Antimicrobial blue (fine Phoscol) 2	8
47	AK102119	Air regulator, grip, light gray, life, walls	1
48	AK102119	On-off tap, grip, light gray, life, walls	2

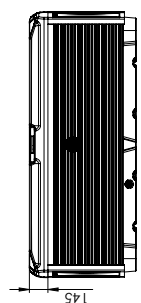

You must install a 30 mA residual-current device (RCD)

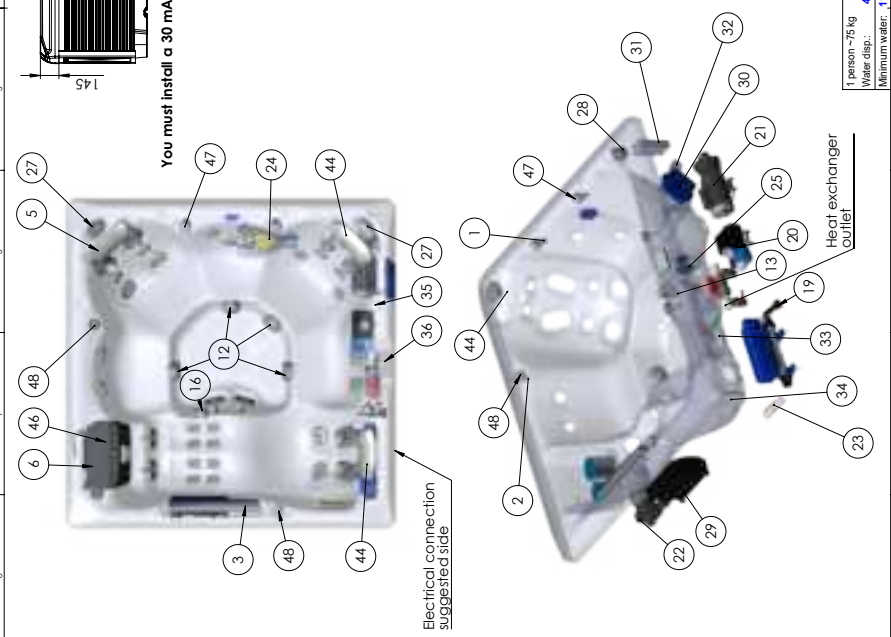

Product family: **Wells/Peak/Life**

Sheet name: **Atlas Life USA**

File name: **FJ.WM00776.ENG.Atlas_Life_USA_misdesign**

Dimension SPA: **2750x2150x685 mm** | Min. Et. ins: **240 V - 30A - 60Hz / Op.Et. needs: 240V - 50A - 60Hz**

Weight of the SPA: **391 kg** | Rekap: **22004950 - AE00382** | Control box: **GEKO YFS + K1000**

Rim height: **145 mm** | Approved by: **Rest Tables** | Part No: **WM00776** | Number: **WM00776**

Created: **2024-04-12** | Drawer: **rest.lamas - 2024-04-10, 9:57:15** | Part No: **A3** | M: **120** | page **1 / 2**

CONNECTION DIAGRAM

MANDALA LIFE

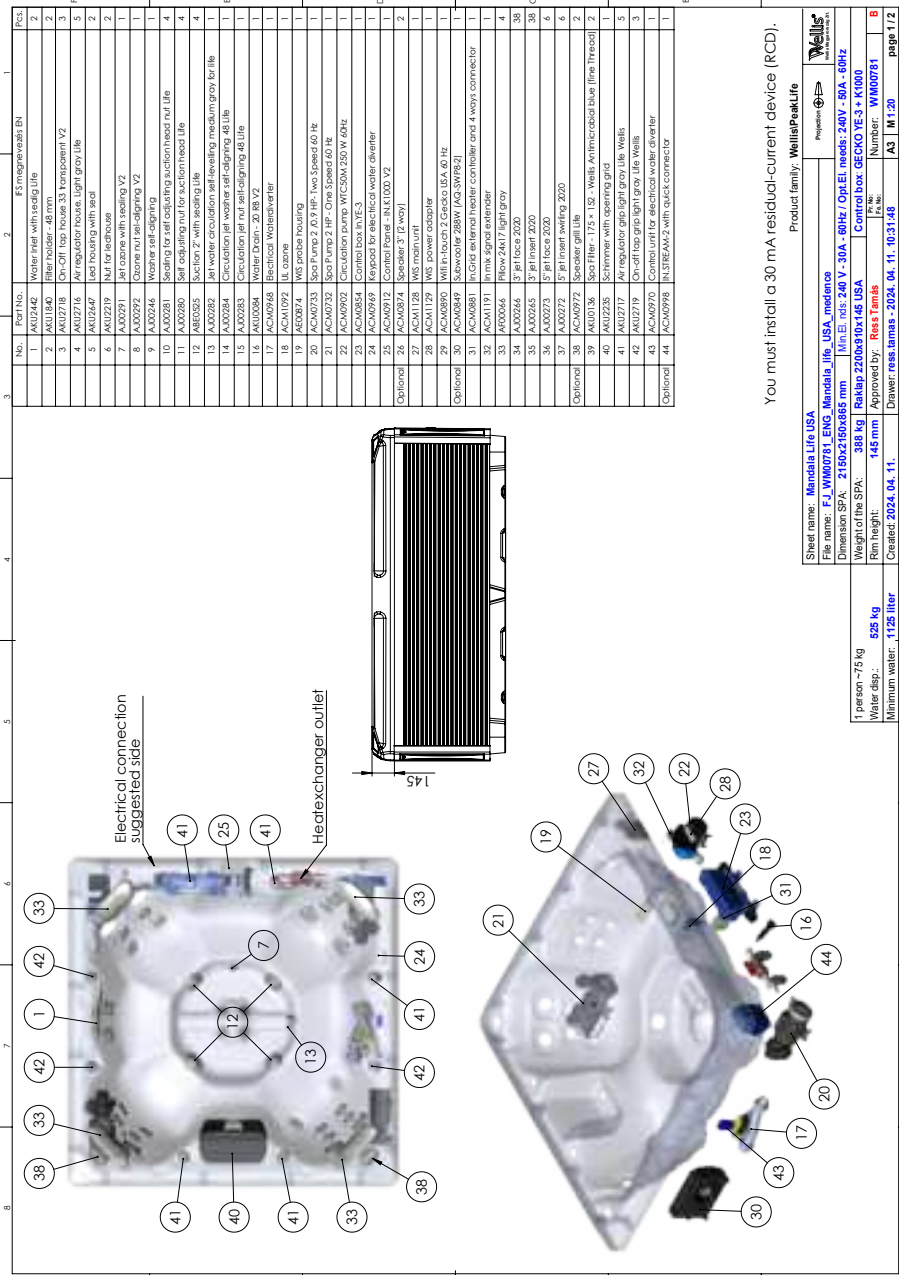

You must install a 30 mA residual-current device (RCD).

Sheet name: Mandala Life USA	Product family: WellisPeakLife
File name: F:\W00781\ENG_Mandala_Life_USA_mandace	
Dimension SPA: 2750x2750x485 mm Min. EI: 248 V - 30A - 60Hz / OPEL: needs: 240V - 50A - 60Hz	
Weight of the SPA: 388 kg Paklap 2200x100x45 USA	Control box: GECKO TE-3 + K1000
Rim height: 145 mm	Approved by: Resi Tanks
Number: W00781	Number: W00781
Created: 2024.04.11	Drawer: res. jama - 2024.04.11, 10:31:48
	AS3 M120 page 1/2

CONNECTION DIAGRAM

TEIDE LIFE

No.	Part No.	Description	Pcs.	
1	AJ0002	Blow fitting tool life	6	
2	AL0218	On-call tap house 33 increase V2	2	
3	AL0214	A1 Regulator 33 increase light grey life	3	
4	AL0243	Cup holder light - bare walls 2020	2	
5	AL0248	Cup holder light nut	2	
6	AL0247	and housing with seal	2	
7	AL0219	Nut for tap house	2	
8	AJ0091	Jet ozone with sealing V2	1	
9	AJ0092	Ozone nut self-aligning V2	1	
10	AJ0084	Water self-aligning	1	
11	AJ0094	Jet water circulation self-aligning light grey 48 life	1	
12	AJ0088	Circulation jet water self-aligning 48 life	1	
13	AJ0085	Circulation nut self-aligning 48 life	1	
14	AJ0086	Jet water circulation 2020	2	
15	AJ0078	Jet filter cap 2020	2	
16	AJ0081	Sealing for self-closing suction head nut life	2	
17	AJ0080	Self-aligning nut for suction head life	2	
18	AB0255	Suction 2 with sealing life	2	
19	AJ0184	Filter holder - 20 life	2	
20	AJ0084	Water Drain - 20 life V2	1	
21	AJ0074	Spout Pump 3 HP - One Series 60 Hz	1	
22	ACM092	Circulation pump W/CMO 250 V 60Hz	1	
23	ACM054	Control box IN YES Gactco 160V 150Hz V3	1	
24	ACM053	Control box IN YES Gactco 160V 150Hz V2	1	
25	ACM087	LED external heater Controller and 4 ways connector	1	
26	ACM1191	ms signal extender	1	
27	ACM1072	LED extender 12/5 V	1	
28	ACM0901	WiFi receiver in touch 2 Gactco BL/UK	1	
29	ACM1128	MS main unit	1	
30	ACM1129	MS power adapter	1	
Optional	31	ACM0958	N3PE AMZ with quick connector	1
Optional	32	ACM0849	Subwater 280W	1
Optional	33	ACM0974	Powerbox 3 (2 way)	1
Optional	34	ACM0972	Powerbox 2 (2 way)	1
35	AJ0079	Jet filter cap 2020	14	
36	AJ0071	5 Jet insert spinning 2020	1	
37	AJ0072	5 Jet insert spinning 2020	5	
38	AJ0070	5 Jet insert diaphragm 2020	8	
39	AJ0066	5 Jet insert 2020	16	
40	AJ0065	5 Jet insert 2020	16	
41	AL0219	On-call top grip light grey life walls	2	
42	AL0217	A1 regulator grip light grey life walls	16	
43	AL0235	Schime with opening grid	3	
44	AJ0066	Blow 24K17 light grey	3	
45	AL00134	Spout life 175 x 152 - Wells A1/microbial blue life	2	
46	ACM0890	WiFi in touch 2 Gactco USA 60 Hz	1	

Electrical connection suggested side

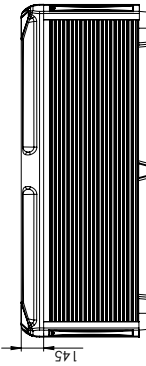
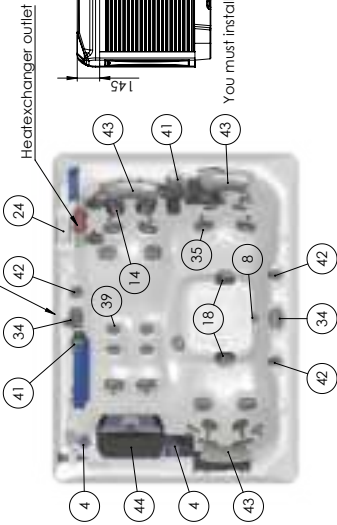

You must install a 30 mA residual-current device (RCD).

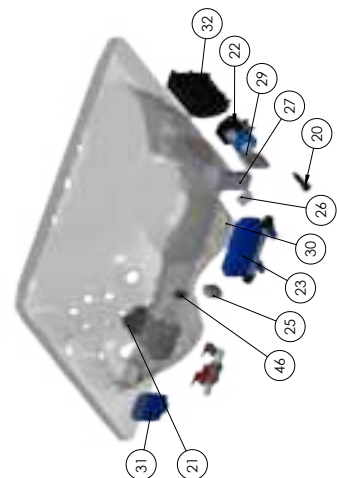

Product family: **Wells|PeakLife**

Sheet name: **Teide Life USA**

File name: **F:_W000777_ENG_Teide_Life_USA_medicine**

Dimension SPA: **1600x2750x885 mm** | Min. E: **res: 248 V - 30A - 60Hz / OPEL: needs: 240V - 40A - 60Hz**

Weight of the SPA: **311 kg** | **Repack 1650x910 USA - AE00897** | **Control box: GECTCO TE-S + K1000**

Rim height: **145 mm** | **Approved by: Resi Tanks** | **Number: W000777**

Created: **2024.04.16** | **Drawer: res. Jamas - 2024.04.15: 15:34:56** | **AS3 | M120** | **page 1 / 2**

1 person - 75 kg
Water disp.: 225 kg
Minimum water: 750 liter

INITIAL INSTALLATION

Electrical preparations:

A clearly labeled emergency switch shall be provided as part of the installation. The switch shall be readily accessible to the occupants and shall be installed at least 5 feet (1.52 m) away, adjacent to, and within sight of, the unit.

Before installation the hot tub, the electrical system has to be prepared, as detailed in the below table.

Applicable cable: Copper 90°C (194°F) THHN/THWN	Ampere rating of the supply circuit overcurrent protective	AWG rating of the supply conductor
Everest Life	50A	6
Kilimanjaro Life	50A	6
Elbrus Life	50A	6
Atlas Life	50A	6
Mandala Life	50A	6
Teide Life	40A	6

INITIAL INSTALLATION

SITE PREPARATION

When choosing a site for the hot tub take into account that its maintenance and repair works must be carried out behind the sidewalls, so accessibility and hot tubce to walk around the hot tub must be ensured.

1. INDOOR/BASEMENT INSTALLATION

If you place your hot tub indoors, be aware of some special requirements:

Water may accumulate around the hot tub, so the flooring material must have a proper runoff to avoid accumulation of water. When building a new room for the hot tub, constructing a floor drain is required, or damages may occur due to overflow, overfilling, or technical failure. Our company does not take responsibility for any damage in absence of floor drainage. Humidity will naturally increase in the room where the hot tub is located and the evaporated water condenses. For this reason ensure that the area has proper ventilation. We recommend installing a dehumidifier in the room.

2. OUTDOOR AND PATIO INSTALLATION

A solid horizontal foundation is necessary for installation of the hot tub. We advise using a reinforced concrete foundation at least 10-15cm thick. Do not shim the spa, it may casue not repairable damages. The base to be even and horizontal.

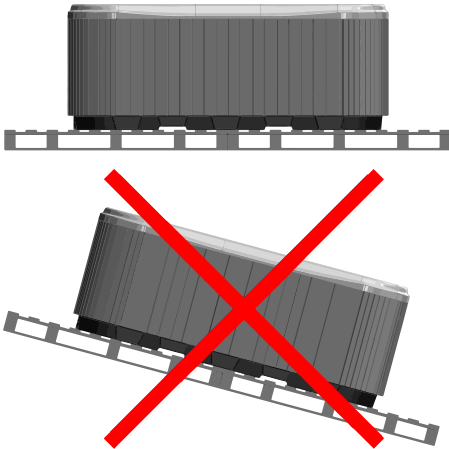

Ensure that your deck or foundation will support your hot tub. You must know the maximal load capacity of the foundation. Consult a qualified building contractor or structural engineer.

To find out the weight of your hot tub, its contents and occupants please refer to the hot tub specification chart. This weight must not exceed the structure's rated capacity per square meter, otherwise serious structural damages could result. If you install the hot tub outdoors, we recommend a reinforced horizontal concrete pad at least 10-15cm thick.

Install floor drains around your hot tub to lead water away even in heavy rain.

When constructing the water drain it is advised to form a 10-15cm deep sloping ditch around the hot tub which directs water to the drain. Water from the drain must be directed to the canal or a drainage with enough capacity.

Warning: Do not expose the hot tub to direct sunlight (not even empty) without proper coverage. The insulated hot tub cover preserves the water temperature and provides protection from sunlight and rain. When exposed to sunshine for a longer period it may damage the surface of the hot tub and the hot tub equipment.

Acrylic rapidly absorbs heat from sun rays, thus reaches a very high surface temperature which may damage the hot tub.

In case of sealed design, if the hot tub was placed between glass structures, prevent the sun rays from reaching the hot tub directly through the glass as the temperature may get too high.

3. IN-GROUND / SUNKEN HOT TUB

In case of sinking the hot tub into the ground you must make sufficient space for walking around the hot tub. For completion of maintenance works a minimum of 60cm wide inspection pit must be built around the hot tub.

The inspection pit's bottom must be under the bearing pont of the hot tub so that water can flow into the pit in case of water leakage. A floor drain or sump pump should be used at the bottom of the pit to ensure continual water drainage.

In case of sinking the hot tub only the portion below the hot tub's acrylic edge can be sunk. The air of the inspection pit steams up. To prevent unpleasant odors proper ventilation must be provided (e.g. installing ventilators). The costs of pulling the hot tub out of the ground are borne by the user. If the aforementioned conditions are not present, setting up the hot tub may fail.

First filling of the hot tub

Proper filling of the hot tub is an important task both technically and chemically. We advise installation and periodic maintenance by the servicing professionals, which includes inspection and refilling of hot tub water. Hot tubs do not contain water softener and hard water damages the equipment. Improper filling of the hot tub may bring air into the system, which damages the heating wire and engines. Repairs after such failures are not covered by warranty.

INITIAL INSTALLATION

Filling process

Remove the hot tub cover. First remove the cover staves, then remove the side covers by unscrewing the bottom screws. During transportation the flare fittings of engines may dislocate. Check these connections before installation. If necessary, tighten the flare fittings.

Before filling the hot tub check that the Slice valves are not in a closed state (lever is pulled out and fixed with the safety lock).

Next fill the hot tub with water to the sign indicated on its sidewall.

Filling must be done through the filter housing. Improper filling can damage the engines and heating element.

Insert the filter or filter cartridges when proper water level is reached. Be cautious, because when replacing the filter cartridge air bubbles may remain in the cartridge. To avoid this the filter cartridges must be tilted in the water to remove air from them, and only then fitted to their place.



INITIAL INSTALLATION

IONIC EXCHANGE WATER SOFTENER AND CARBON FILTER

For the optimal quality the following steps shall be followed during the usage:

1.

Please check the required water volume in the manual of the spa or contact our customer service for help. The exact volume is needed for the precise filling.

2.

Please remove the covering caps from both ends to connect the filling hose.



3.

Please connect the carbon filter to the water hose via the screw thread gadget (included with the filter).



4.

Please run water through the filter into a separate vessel until it becomes perfectly clear. This step allows the filter to rinse from the remaining carbon powder. The rinse cycle lasts for 30 seconds at most with approx 10 litres of water.



0'-30'



>30'

5.

Through the clean filter fill up the spa with one third (1/3) of the total volume (e.g.: with 1000 litres of total volume 1/3 is 300 litres). It is important to follow the instructions of the filling for it is crucial to set the precise water hardness.



Insert the filter or filter cartridges when proper water level is reached. Be cautious, because when replacing the filter cartridge air bubbles may remain in the cartridge. To avoid this the filter cartridges must be tilted in the water to remove air from them, and only then fitted to their place.

6.

After the filling please remove the caps from the water softener cartridge too and connect it with the carbon filter. With water softener the rinsing is significantly faster, so only this first 1 liter needs to be drained separately!



7.

Please check the water hardness during the filling with the softener. There are multiple choice of using a hardness tester. Testers sold by Wellis are showing the hardness level on a colour scale.

If the value shown is less than the optimal value the water will create foam during the usage, if the value is more that will cause limescaling.



8.

If the water hardness is extremely low during the filling please remove the softener cartridge and continue the filling with only the carbon filter as it shown at point 5.

MAINTENANCE

FILTER CARTRIDGE REMOVAL AND CLEANING

Cleaning mechanical contaminations via continuous water circulation and chemical mixture is a basic requirement for proper cleaning of the spa water. Every spa has an engine designed for this purpose. The circulation engine circulates the water through the filter(s). The filter protects against contamination floating in the water.

Cleaning of the filter cartridges is recommended weekly.

Soaking the filter cartridges in water mixed with chlorine or antialgae agents for 24 hours is recommended monthly.

Changing the filter cartridges is necessary every 3 months.

SURFACE MAINTENANCE

Wipe the surface with a wet cloth. Always use a neutral cleaning product and a soft wiping cloth. Never scratch the acrylic surface with an abrasive tool, blade, or knife, because it may cause damage. Never use nail polish remover, acetone, or paint stripper when cleaning the surface because it may cause damage.

Maintenance manual for the control panel of the spa:

- Do not damage the control panel with anything hard. If possible,
- Avoid exposing the control panel to direct sunlight.
- When not using the spa, always use a spa cover.

WINTERIZATION

Remember to correctly maintain the spa if you are not using it in the winter. If you are not using your spa during the winter months and want to put it out of service properly, call one of our qualified professionals to winterize your spa at a prearranged date and time.

The winterization encompasses the following:

- Drainage of used water
- Cleaning of the inner surface of the spa
- Dewatering of pipe and jet system
- Dewatering and disconnecting the engine's interface
- Delivery - reception

If the spa is not winterized properly, the system can retain water that can easily freeze during the winter months. This can cause heavy irreparable damage to the pipes and the engine. This will void the warranty.

Maintenance of the out-of-service spa:

When you are not using the spa, use the thermo cover and fasten it with the buckles. Do not forget! If the spa is filled with water and you are not using it, lift the cover at least once a week to ensure proper ventilation. The thermo cover is multipurpose. Most importantly it decreases the heating time of the water to operational temperature and decreases the energy needed to maintain water temperature, decreasing the operational costs.

Using the cover you can avoid leaves, rain, snow, or other contamination entering the spa water, effectively sealing it off from environmental effects.

Fastening the cover with buckles prevents young children from using it without parental supervision.

CLEAN THE FILTER CARTRIDGES WEEKLY AS FOLLOWS:

WARNING!

Changing the filter cartridges is recommended every 3 months!

Operating the spa without a filter cartridge is PROHIBITED

1. Remove the lid of the filter.
2. Take out the filter cartridge.
3. Clean contamination from the cartridge with water.
4. Soak the cartridge in lukewarm water mixed with chlorine or antialgae agents for 1-2 hours, then rinse it.

Never use an alkaline detergent or a high-pressure cleaner to clean the filter!



DRAINING THE WATER

You can drain the water via the drain outlet in accordance with environmental standards.

1. You'll need a hose a wet and dry vacuum cleaner and a bottle of wellis crystal spa cleaner fluid.
2. Pour the cleaner fluid into the water one day before draining and run the open jets at maximum performance for 20 to 25 minutes. The cleaner will remove any lime scale and dirt from the spa and its pipe work.
3. Before draining the spa remove the filters, this is a good time for cleaning or replacing them.
4. You don't need a pump for draining the water pull out the draining valve to the limit.
5. Remove the cap and attach the hose.
6. Push back the valve halfway then rotate and secure it in this position, this will start the flow of water. We recommend rinsing the tub while it drains
7. When the tub is empty remove the hose and close the valve.
8. Use a wet and dry vacuum to clean up any remaining water from the spa and the jet nozzles.



IN LINE QUICKSTART GUIDE

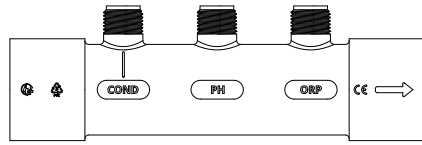
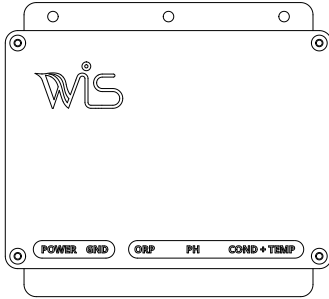

1.

Power off the spa

For your safety, it is best to turn off the main power supply

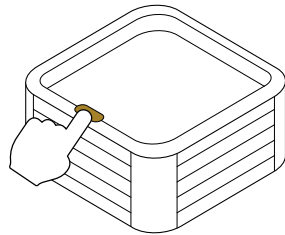

2.

Open the side panel of your spa to access the unit control box



Installation must be done by a professional

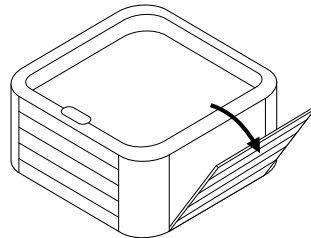

3.

Close the slice valves

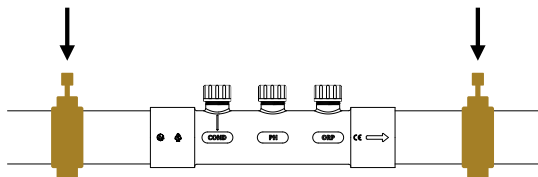

4.

Remove the manifold caps

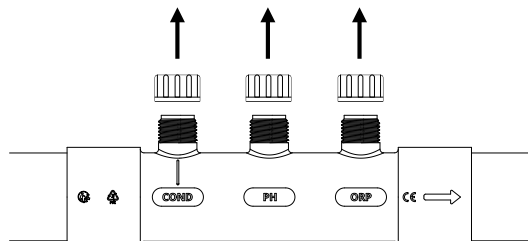

IN LINE QUICKSTART GUIDE

5.

Install the compression fittings



Store the sensor boxes and end caps

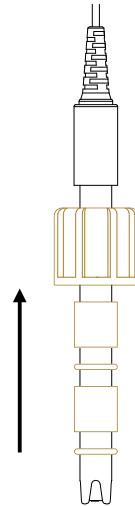
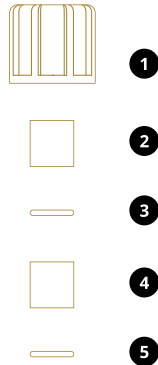

6.



Turn conductivity sensor: water flow passing through the hole

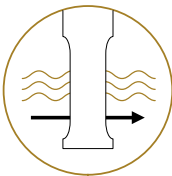

Screw the sensors on the manifold



Place the sensors in the manifold, with respect to the flow direction:

- 1. Conductivity sensor
- 2. pH sensor
- 3. ORP sensor

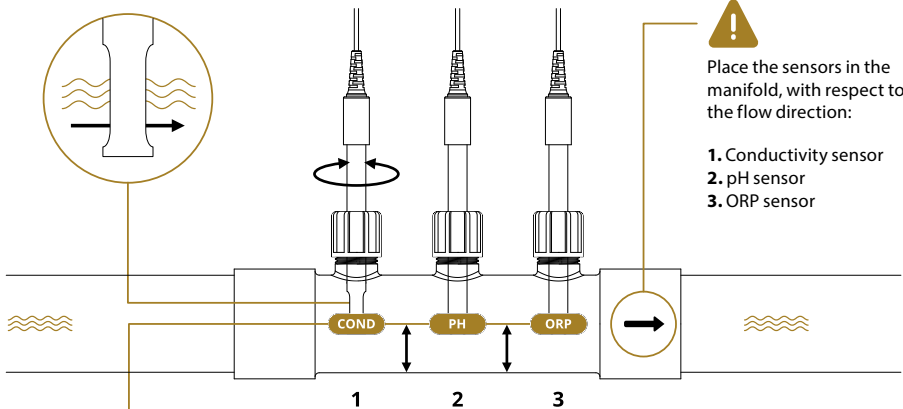

Place the end of the sensors in the middle of the manifold

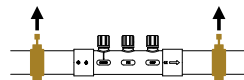

Open the slice valves

IN LINE QUICKSTART GUIDE

7.

Connect the sensors to the control box

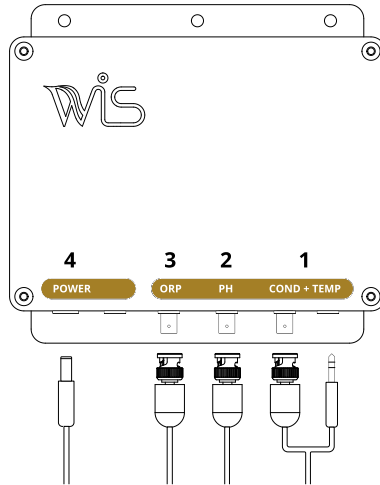

8.

Restore the power supply to the Spa to turn on WIS IN LINE

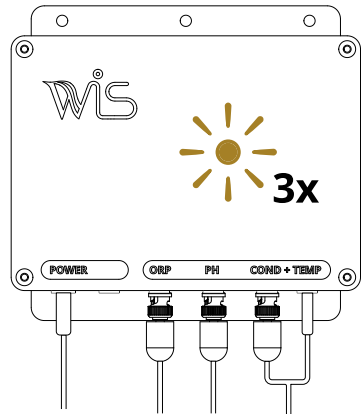
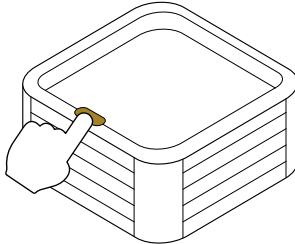

9.

Download the application (free App)



Q WIS - CONNECTION TO YOUR SPA



Download the application on the user's phone

IN LINE QUICKSTART GUIDE

10.

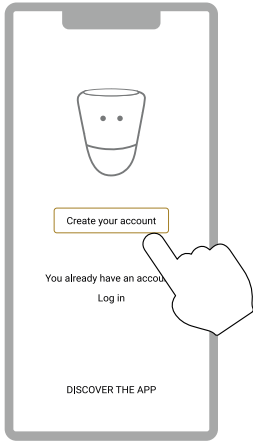

Create your account

11.

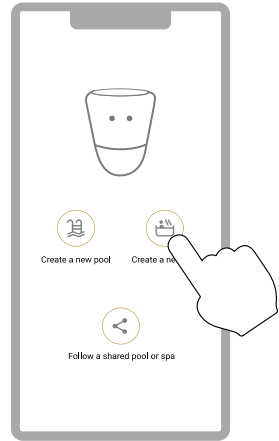

Create a new spa

12.

Scan QR code and follow the instructions

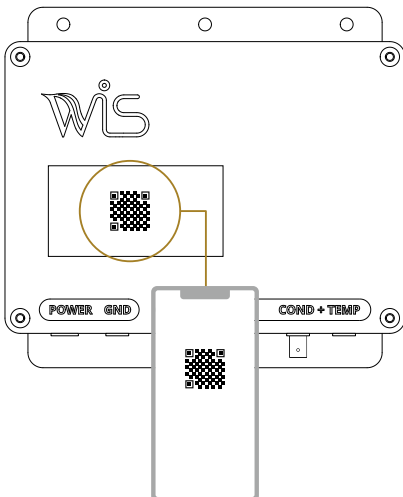

13.

Follow the WiFi connection steps in the app

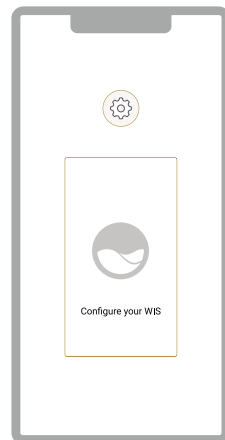

Configure your WIS

JET DIRECTIONS

EVEREST LIFE



JET DIRECTIONS

KILIMANJARO LIFE



JET DIRECTIONS

ELBRUS LIFE

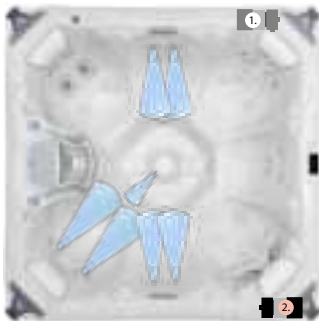
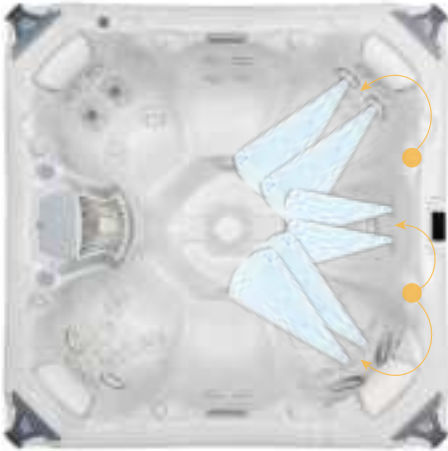
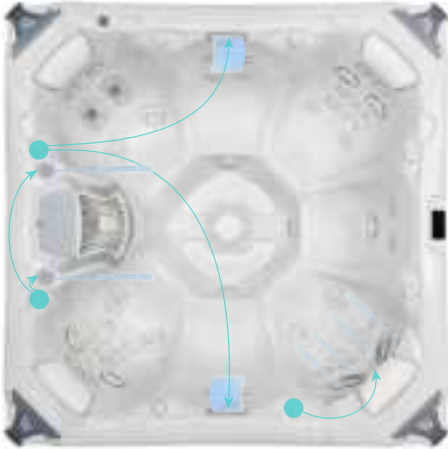

JET DIRECTIONS

ATLAS LIFE

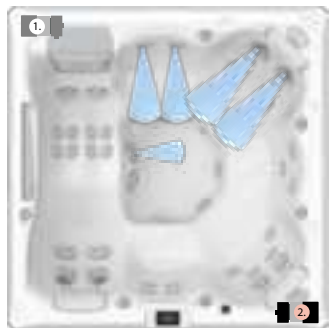
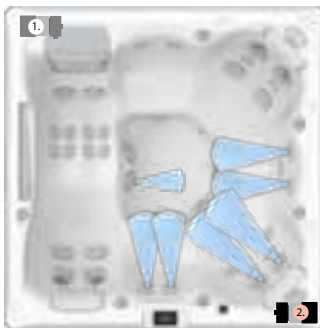

JET DIRECTIONS

MANDALA LIFE

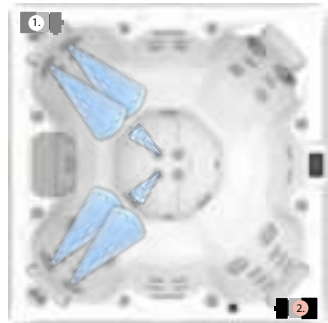
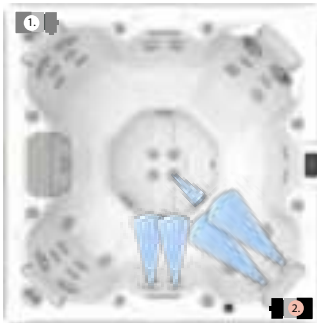
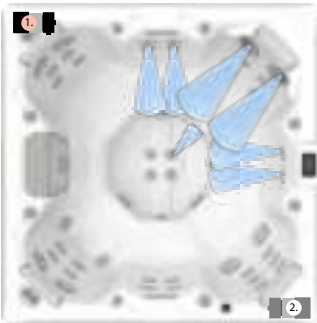
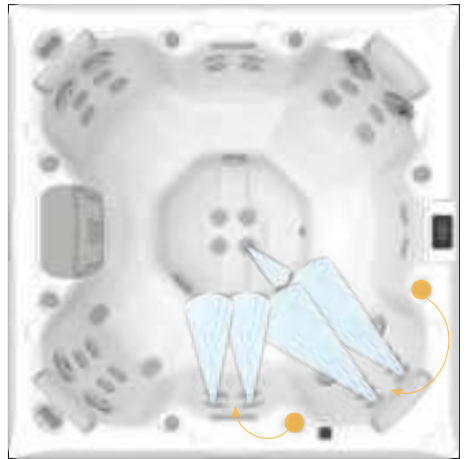
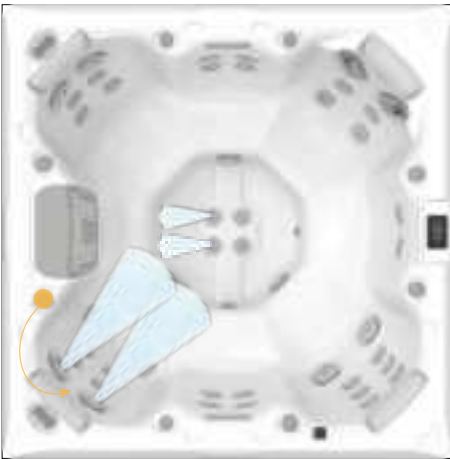
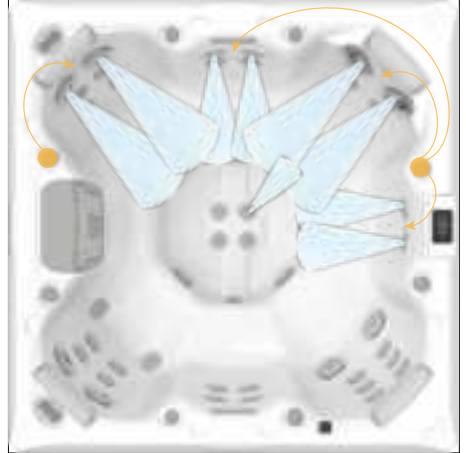

JET DIRECTIONS

TEIDE LIFE



USER INTERFACE - SMART TOUCH

SMART TOUCH

TOUCH SCREEN KEYPAD

No buttons, keys and overlays! Mode and function selection wheels, all-on or all-off one touch activation key of last used settings, interactive display icons and on-screen messages are all elements of the Smart Touch user interface designed to let spa users interact intuitively with their spa and its value-added accessories.



NOTIFICATION ICONS

Notification icons at the top right-hand side of the screen show the status of connected value-added accessories.



SPAS FUNCTIONS

Quick and easy step-by-step instructions to control the main functions and to configure the system settings of your spa from its Smart Touch main keypad.



TURN KEYPAD ON

3 minutes after the last pump is turned off, the screen will shut off if there is no touch activity.

Touch the screen to turn on the keypad. Then follow the instructions on the screen to access the main screen.



ALL-ON, ALL-OFF TARGET KEY

Smart Touch features an all-on or all-off one touch activation key of last used settings that, when pressed, stops or starts all working components and accessories at once.

From the home page you can access the following modes:

- sanitization (with in.clear connected)
- audio (with Aquasoul Pro connected)
- color (with in.mix installed)
- spa
- settings

To select a mode, slide the left wheel up or down until the desired icon menu is highlighted in the middle.

USER INTERFACE - SMART TOUCH

SPA MODE



SPA MODE

To select the spa mode, slide the left wheel up or down until the spa icon is highlighted in the middle. The home page will be displayed its equipment start or stop keys, up and down buttons, water temperature, messages and quick access to display options:

- display orientation
- display contrast

To select an option, slide the right wheel up or down until the desired icon menu is highlighted in the middle.



START OR STOP ACCESSORIES

To start or stop an accessory (pump, blower, light), touch the associated icon. Icons will become animated when their accessory is turned on, and animation will stop when turned off.

Icons on the screen will reflect the speed or state of the devices running on your spa. When an accessory has more than one speeds press the button until it reaches the desired speed.



WATER TEMPERATURE

The temperature shown at the bottom of the screen shows the current water temperature. Use the Up and Down icon to set the desired temperature. The set point will appear in blue. After 3 seconds without any change to the set temperature value, the current water temperature will reappear.

When the set value is lower than the current temperature Cooling to xx.x will appear below. When the set value is higher than the current temperature, Heating to xx.x will be indicated under the value. Normally there is a short delay before the heating starts, during which Heating Suspended is indicated under the value.



DISPLAY ORIENTATION

To modify the display orientation settings, slide the right wheel until the display orientation icon is highlighted in the middle. Simply touch the line of the orientation you want to select.

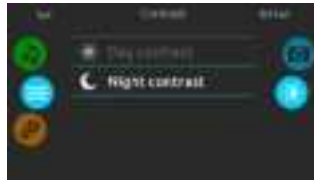

DISPLAY CONTRAST

To modify the display contrast settings, slide the right wheel until the display contrast icon is highlighted in the middle. Simply touch the line of the contrast you want to select.



SLEEP MODE

Press key to go directly into the sleep mode. In sleep mode, water splashing on the keypad can't inadvertently start/stop a pump.

USER INTERFACE - SMART TOUCH

SETTINGS

You can use the Settings mode to manage settings of your spa system.



To select the settings mode, slide the left wheel up or down until the settings icon menu is highlighted in the middle.

In the Settings page you can access the following:

- water care
- maintenance
- date & time
- keypad
- electrical configuration
- wifi
- about

To select an item, slide the right wheel until the desired icon is highlighted in the middle or press on the menu name.

WATER CARE

The Water care page will help you set up your ideal filtration and heating settings.

Choose, set or modify one of the 5 suggested modes depending on your needs at any given time.



AWAY FROM HOME

In this mode the spa will always be in economy; the set point will be reduced by 20° F.



BEGINNER

The spa will never be in economy mode and will be filtering according to the pack's low level configuration.



ENERGY SAVINGS

The spa will be in economy mode during the peak hours of the day and resume normal mode on the weekend.



SUPER ENERGY

The spa will always be in economy mode during peak hours, every day of the week.



WEEKENDER

The spa will be in economy mode from Monday to Friday, and will run normally on the weekend.

MODIFYING WATER CARE SCHEDULES



WATER CARE

To modify a Water care category, touch the pen icon at the right end of the desired water care to open the selected Water Care menu.



ECONOMY

Touch the Economy tab to change the economy schedule. You can add economy schedules by touching the « + » symbol . To delete a schedule, touch the garbage can icon at the right end of the desired line.



FILTER CYCLES

Touch the Filter cycle tab to change the filter cycle schedules. You can add filtration schedules by touching the « + » symbol . To delete a schedule, touch the garbage can icon at the right end of the desired line.

USER INTERFACE - SMART TOUCH

MODIFYING WATER CARE SCHEDULES



In Economy mode, the set point will be reduced by 20°F, which means that the heating system will not be engaged unless the temperature falls to 20°F below the spa's set temperature.

The filtration schedule shown on the screen will apply to the main filtration pump, most likely pump 1. If your spa uses a circulation pump configured to run 24 hours, the screen will show you the purge setting instead of filtration. The purges are pre-programmed for a fixed number of minutes, therefore the duration will be set to N/A on the screen, and only the start time can be modified.

You can modify the programmed schedules by selecting one and adjusting the schedule.

You have several possibilities for the schedule (Mon-Fri, weekend, every day, or single days). The schedules will be repeated every week. The time and duration are set in 30 minute increments.

Once you have set the schedule, use the calendar icon to go back.



PURGES

Touch the Purge tab to change the purge settings. You can add purges by touching the « + » symbol.

To delete a schedule, touch the garbage can icon at the right end of the desired line.

You can modify the programmed purges by selecting one and adjusting the schedule.

You have several possibilities for the schedule (Mon-Fri, weekend, every day, or single days). The schedules will be repeated every week. The time and duration are set in 30 minute increments. Once you have set the purge, use the calendar icon to go back.

USER INTERFACE - SMART TOUCH

MAINTENANCE & ERROR LOG

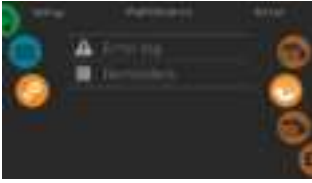

MAINTENANCE

To modify maintenance settings, slide the right wheel until the maintenance icon is highlighted in the middle.

From the Maintenance page you can access the following:

- Error log
- Reminders

Simply touch the line of the item you want to change.

STANDBY

The Standby mode allows you to service your spa. Pumps will stop for 30 minutes and will automatically restart after.

The normal page will return at the end, once the pumps will be restarted.

REMINDERS

Smart Touch keypad will provide reminders about maintenance required on your spa, like rinsing or cleaning the filter. Every task has its own duration, based on normal use.

The reminders menu allows you to check the time left before maintenance is required, as well as to reset the time once a task has been completed.

To reset a task, select it by pressing the curved arrow, then confirm when prompted. Once you have confirmed, the task will be reset.

DATE AND TIME

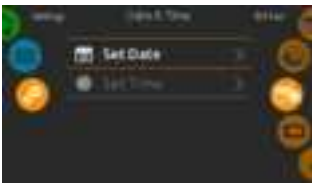

DATE AND TIME

To modify date and time settings, slide the right wheel until the date and time icon is highlighted in the middle.

Simply touch the line of the item you want to change.

SET DATE

Here you can adjust the year, month and date. Simply swipe up and down the column you want to change, and select the desired value. When done, touch the calendar icon at the right of the screen.

SET TIME

Here you can change the hour, minute and time format. Simply swipe up and down the column you want to change, and select the desired value. When done, touch the calendar icon at the right of the screen.

USER INTERFACE - SMART TOUCH

KEYPAD SETTING

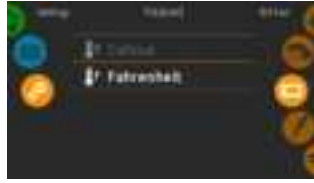

KEYPAD SETTINGS

To modify keypad settings, slide the right wheel until the keypad icon is highlighted in the middle.

Simply touch the line of the item you want to change.

TEMPERATURE UNITS

Use this page to set or change the temperature in F° or C° units.

DISPLAY ORIENTATION

Use this page to set or change the normal or inverted display orientation.

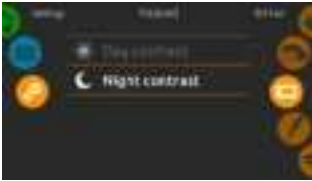

DISPLAY CONTRAST

Use this page to set or change the display day or night contrast.

DISPLAY LANGUAGE

Use this page to set or change the display language.

KEYPAD LOCK/UNLOCK



When this option is enabled, the user can partially or completely lock the keypad. When the user wants to lock the keypad he is asked to select a 4-digit code. The same code will be needed to unlock the keypad. Next time he wants to lock the keypad, he will be prompted again to select a 4-digit code (same functionality as a Safe in a hotel room).

The keypad can be unlocked with a universal unlock code (3732) or by a reset of the keypad.

When Full Lock is selected, all functions are locked.

In Partial Lock, you may only activate accessories. Settings may not be changed in this mode.

USER INTERFACE - SMART TOUCH

WIFI

(This function is available only if an in.touch module is connected to your system.)



WIFI SETTINGS

To modify wifi network settings, slide the right wheel until the wifi icon is highlighted in the middle.



WIFI NETWORKS

After a few seconds the available networks will appear on the screen, as well as their signal strength.

Selected network will be identified by a green check mark.

Swipe Up or Down the list to select your network.



WIFI NETWORK PASSWORD

If the wifi network is password protected, enter it when keyboard prompts. Use Enter key to validate the password.

If no password is required the in.touch will connect automatically.

WIFI



IN.TOUCH MODULE NOT CONNECTED

If the in.touch module of your spa system is not connected, this message will be displayed.

WI-FI (in.touch 2)



When an in.touch 2 is detected, this network will appear.

MISCELLANEOUS



This menu gives access to modify the Warm Weather option and info messages in the media center.

WARM WEATHER



When pumps are running, they produce heat that may increase your water temperature. "Warm Weather" option gives you the option to bypass the pack filtration over temperature feature. When Warm Weather is "OFF" the filtration over-temperature is disabled and your spa filtering will continue even if the water temperature is high.

ABOUT YOUR SPA SYSTEM

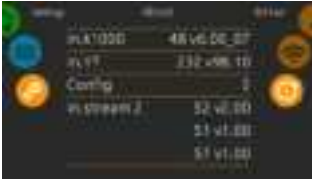

ABOUT

To get info about your spa system, slide the right wheel until the about icon is highlighted in the middle.

Information about Smart Touch software number and the revision numbers of the different components of your system will be displayed.

ELECTRICAL CONFIGURATION



Please do not make changes in this section unless you are a qualified electrician.

A password will be required. Please contact a representative in order to obtain that password.



To change the low-level configuration, the number of phases and the input current of your spa system, slide the right wheel until the electrical configuration icon is highlighted in the middle.

USER INTERFACE - SMART TOUCH

AUDIO MODE

(only available if the system detects a connected Aquasoul Pro audio station)



To select the audio mode, slide the left wheel up or down until the audio icon menu is highlighted in the middle.

In the Audio page you can access the following:

- Aquasoul Pro on/off
- speaker calibration
- audio source selector
- bluetooth pairing

To select an item, slide the right wheel until the desired icon is highlighted in the middle.

ON/OFF



TURN AQUASOUL PRO ON

Slide the right wheel until the power on/off icon is highlighted in the middle. Press on the audio icon at the center of the screen to turn Aquasoul Pro on.

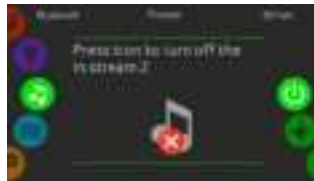

TURN AQUASOUL PRO OFF

Press on the audio icon in the center of the screen to turn Aquasoul Pro off.



MAIN DISPLAY

Press Play / Pause to start or pause playback of audio files.

Drag the volume slider to adjust the volume or tap the mute button to mute or unmute sound.

Press the last track or next track buttons to go to the previous song or skip to the next.

USER INTERFACE - SMART TOUCH

SPEAKER CALIBRATION



TO CALIBRATE YOUR SPEAKERS

Slide the right wheel until the speaker calibration icon is highlighted in the middle.

You can calibrate:

- balance
- fade
- subwoofer

Use the sliders to calibrate the speakers at the desired level.

The fade and subwoofer sliders will only appear on the screen if the corresponding speakers are installed on Aquasoul Pro.

AUDIO SOURCE SELECTOR



TO SELECT AN AUDIO SOURCE

Slide the right wheel until the source icon is highlighted in the middle.

In the menu list, the following sources are available:

- Bluetooth
- USB
- Aux. 1

Simply select the desired one to use.

Note that only the sources installed on Aquasoul Pro will be displayed in the source menu. The USB and Aux. 1 connections are on the in.stream2 unit, they are not led out.

Please note that the Play/Pause and Change Track functions apply to devices using Bluetooth technology and USB, and will not work when AUX is selected as the source.

Please refer to the Aquasoul Pro connexions section to learn how to connect your Bluetooth device.

BLUETOOTH PAIRING



If you are using a device with Bluetooth technology, it must be connected for functions to work.

Slide the right wheel until the bluetooth icon is highlighted in the middle. Then follow the instructions displayed on the screen.

If a device with Bluetooth technology is connected to Aquasoul Pro, you can disconnect it by pressing the Disconnect button at the bottom of the screen.

Doing so will also prevent Aquasoul Pro from automatically reconnecting to this specific device until it has been reconnected using the device itself.

USER INTERFACE - SMART TOUCH

COLOR MODE

(only available if the in.mix is detected among the spa accessories)

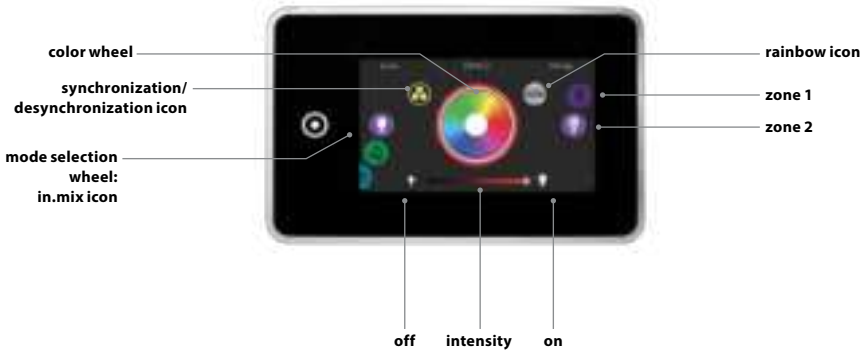

By default, the in.mix selects Zone 2 when you access the menu. To select the color mode, slide the left wheel up or down until the in.mix icon menu is highlighted in the middle.

In the color page you can access the following:

- zone selection
- changing colors
- on/off
- synchronizing zones
- intensity

IN.MIX FUNCTIONS



ZONE SELECTION

To select a zone, turn the right wheel until the desired icon is highlighted in the middle. This selection allows you to modify its color.

CHANGING COLORS

Once a zone has been selected, use the color wheel to choose the desired color, or the rainbow icon to get changing colors.

The rainbow icon alternates between slow transitions, fast transitions and normal color selection.

ON/OFF

There are two ways to turn the in.mix on or off. The first one is by using the Light icon on the SPA Screen. The second way is by touching the light bulb icons located each side of the intensity bar.

SYNCHRONIZING ZONES

The synchronization/desynchronization icon allows you to match the color of the selected zone with the other zones.

INTENSITY

Located at the bottom of the screen, the slider allows you to modify the intensity of the color.

USER INTERFACE - SMART TOUCH

TOO MUCH WATER ON DISPLAY



WIPE SCREEN

This message appears when too much water is detected on the touch screen. Simply wipe away excess water.

INSTALLATION ERROR MESSAGES

Upon connecting Smart Touch to your spa system you may see one of two error messages. Please follow the instructions in the message or contact your dealer for more information.



Error messages on the screen list and definitions:
<http://geckokeypads.com/k1000errormessages>

SMART WINTER MODE (SWM)

There is a thermometer sensor in the control unit that measures the temperature of the machinery. It monitors how cold it is outside the cover - including the insulation - and turns on the motors from time to time to direct hot water into the machinery to avoid freezing.

The SWM (Smart Winter Mode) will not turn on if the sensor measures above 21C. However, if it falls below that, it will turn on for 24 hours.

- if it measures 20-16 degrees, it will run the motors for 1 minute every 2 hours.
- if it measures 15-13 degrees, it will run the motors for 1 minute every hour.
- if it measures 12-11 degrees, it will run the motors for 1 minute every 30 minutes.
- if it measures 10 degrees (or less), it will run the motors for 1 minute every 15 minutes.

This is a safety function which cannot be turned off!

WARM WEATHER FUNCTION

During the filtration cycle, the kinetic heat generated by the circulating motors is transferred to the pool water, so the pool water temperature can possibly rise above the set temperature on the control panel. The control unit continuously monitors the water temperature during the filtration cycle and if it rises above the set temperature by more than 3 degrees celsius, it automatically shortens the duration of the filtration period so the water does not overheat.

Besides continuously measuring the water temperature, it automatically changes the duration of the filtration period, but filters for at least 4 hours if the spa is equipped with a circulating motor, or for at least 2 hours if the water is filtered by the massage motor.

This function can only be turned off on whirlpools equipped with a colour touch screen.

USER INTERFACE - 4 AND 1 SINGLE BUTTON PANEL

ONE SINGLE BUTTON PANEL

AUXILIARY KEYPAD FOR YOUR SPA

This one single button panel is also an auxiliary keypad designed to be installed as a second keypad on your spa. It allows you to activate the spa pump associated to its respective section.

The panel surface allows for an easy installation in any location around your spa.



OTHER ACCESSORIES – ELECTRIC WATER DIVERTER FOR USE

(WOW SYSTEM)

Turning on the water diverter:

If you want to use the electric water diverter, the engine equipped with the water diverter must be switched on. When you start the pump it will start the diverter as well. The pump can be started either from the main panel or from the single button keypad.



Functions

When the pump is switched on, the 3 status lights on the water diverter controller light up, which have two functions: feedback that it is working, and shows the actual direction of the diverter.

A restart resets the water diverter to its default position, which independent of the last used state.



As soon as our system is in the default state, you can enjoy two functions:

You can manually switch between the 3 possible directions:

- The water pressure is applied to everyone by the massage pump (Basic position - middle position)
- jets on the side close to the keypad
- farthest from the keypad

Automatic operation:

- In this function, the water diverter switches the diverter vane between the two end states according to a specific schedule:
 - 0 sec: the diverter is in the first end position,
 - 2.5 sec: the direction changer is in the half position,
 - 5th sec: the flow switch has switched to the second end position,
 - 10th sec: the water diverter remains unchanged in the second end position,
 - 12.5 sec: the direction changer is in half position,
 - 15 sec: the water direction changer is in the first end position,
 - 20 sec: the diverter remains unchanged in the first end position.
- The actual direction can be tracked on the operator, because until one or the other end position is reached, the status indicator in which direction the deflector is rotating will flash.
- The function operates as long as the massage pump is running or the button that started the previous manual function is not pressed.

The entire system can be switched off by stopping the engine! (Pump)

OTHER ACCESSORIES - THE HEAT PUMP

For further information see the original user manual of the heatpump. It shows the installation and technical details.

CONTROL PANEL

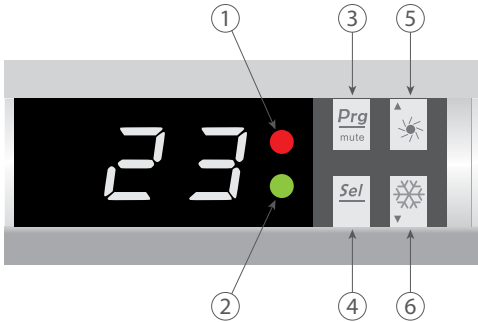

1. Heating mode indicator
2. Cooling/Defrost mode indicator
3. ON/OFF button
4. Mode button
5. Plus (+) button
6. Minus (-) button

OPERATING MODE SELECTOR



BEFORE STARTING, ENSURE THAT THE FILTRATION PUMP IS WORKING AND THAT WATER IS CIRCULATING THROUGH THE HEAT PUMP.

Prior to setting your required temperature, you must first select an operating mode for your remote control:



HEATING MODE

Select the heating mode for the heat pump to heat the water in your spa.





COOLING MODE

Select the cooling mode for the heat pump to cool the water in your spa.

OTHER ACCESSORIES - THE HEAT PUMP

HEATING MODE

Step 1: Press  to switch on your pump.

Step 2: Press  to switch from one mode to another until the heating mode is displayed.

Step 3: Using buttons  and  select the required temperature.

EXAMPLE:

If the current temperature is 15°C, default setting temperature is 27° required temperature is 30°C.

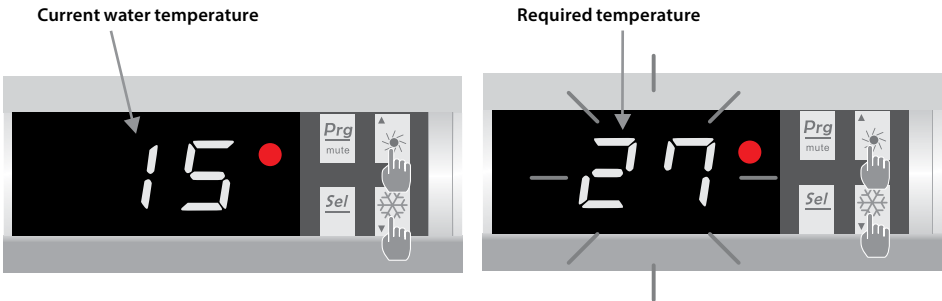

USEFUL INFORMATION ABOUT HOW THE HEATING MODE OPERATES

When the incoming water temperature is less than or equal to the required temperature (setpoint temperature) -X°C, the heat pump will switch to heating mode. The compressor will stop when the temperature of the incoming water is greater than or equal to the required temperature (setpoint temperature).

Indicators for adjustment range X and Y

X: adjustable parameter from 1° to 10°C, default setting is 3°C. (Parameter "H")

OTHER ACCESSORIES - THE HEAT PUMP

COOLING MODE

Step 1: Press  to switch on your pump.

Step 2: Press  to switch from one mode to another until the cooling mode is displayed.

Step 3: Using buttons  and  select the required temperature.

EXAMPLE:

If the current temperature is 30°C, default setting temperature is 27° required temperature is 15°C.

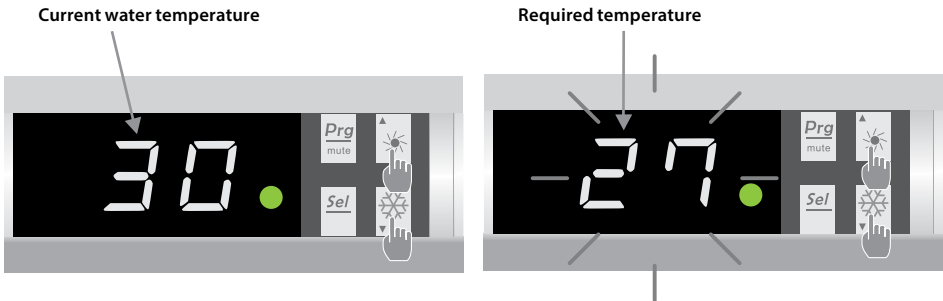

USEFUL INFORMATION ABOUT HOW THE COOLING MODE OPERATES

When the incoming water temperature is greater than or equal to the required temperature (setpoint temperature) + X°C, the compressor will switch to cooling mode. The compressor will stop when the temperature of the incoming water is less than or equal to the required temperature (setpoint temperature).

Indicators for adjustment range X

X: adjustable parameter from 1° to 10°C, default setting is 3°C. (Parameter "H")

OTHER ACCESSORIES - THE HEAT PUMP

STATUS VALUES AND ADVANCED SETTINGS



WARNING: This operation is used to assist servicing and future repairs.
The default settings should only be modified by an experienced professional person.

THE SYSTEM'S SETTINGS CAN BE CHECKED AND ADJUSTED VIA THE REMOTE CONTROL BY FOLLOWING THESE

Step 1: Keep pressing  until you enter the settings verification mode.

Step 2: Press  and  for see the parameters.

Step 3: Press  to select the setting to be modified.

Note, some settings cannot be modified. Consult the settings table for further information.

Step 4: Press  and  to adjust the setting value.

Step 5: Press  to set the new value.

Step 6: Press  to return to the main screen.



PARAMETERS TABLE

N°	Description	Range value	Default value	Comment
A	Water temperature	-19~99°C		Actual data
b	Evaporator temperature	-19~99°C		Actual data
c	Ambient air temperature	-19~99°C		Actual data
d	Setting temperature in heating mode	15~40°C	27°C	Adjustable
E	Defrosting mode activation timer	10~80 min	40 min	Adjustable
F	Defrosting mode maximum duration	5~30 min	8 min	Adjustable
G	Setting temperature in cooling mode	8~28°C	12°C	Adjustable
H	Adjustment of temperature difference for restart	1~10°C	3°C	Adjustable
J	Automatic restart	0=OFF, 1=ON	1	Adjustable
O	Antifreeze protection – low air temperature	-10~15°C	-5°C	Adjustable
P	Evaporator temperature to enter defrosting mode	-19~0°C	-3°C	Adjustable
U	Evaporator temperature to exit defrosting mode	1~30°C	20°C	Adjustable
t	Reserved - Do not modify			Reserved
L	In.grid	0=OFF, 1=ON	1	Adjustable

For further information see the original user manual of the heatpump. It shows the installation and technical details.

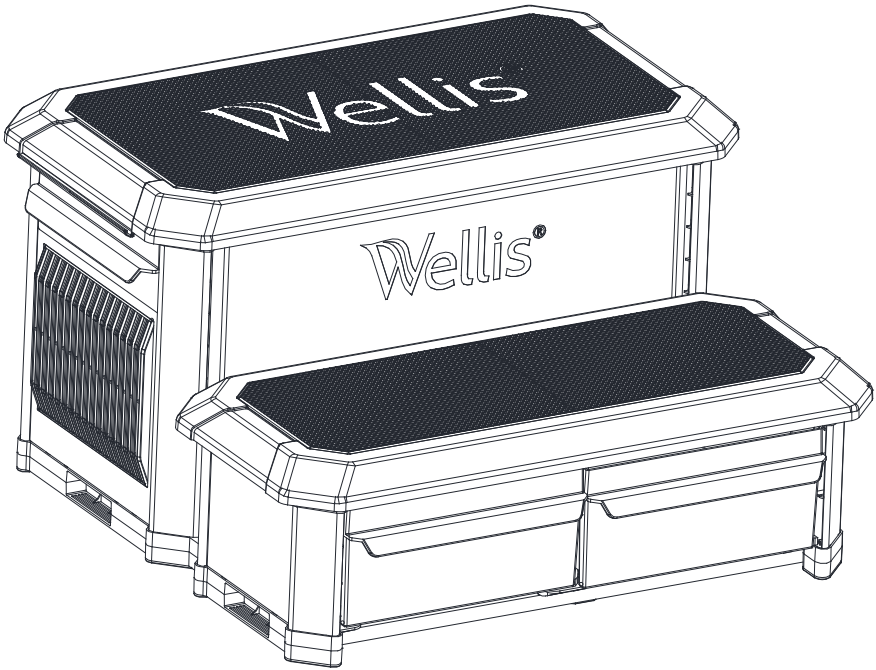

SMART STEP MANUAL (OPTIONAL)

SAFE USE



To reduce the risk of drowning, falls, paralysis, electrocution, or other serious injury or death:

Use step properly.

Use for intended purpose only.

- **No diving or jumping from steps** - shallow water, risk of paralysis or death.
- **ONE PERSON ON THE LADDER/STAIR AT A TIME.**
- **Illuminate the steps** when using the spa at night.

Weight limit - 300 lbs maximum. Exceeding maximum weight may cause the step to fail.

Secure the spa when not in use. - (for example, with a locked cover or secure gate) - refer to local codes.

Watch children at all times when they are in or around water to help prevent drowning.

BE SURE AND SAFE. - The manufacturer **IS NOT** responsible for improper assembly, installation and use.

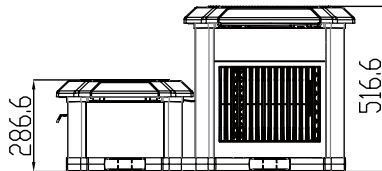
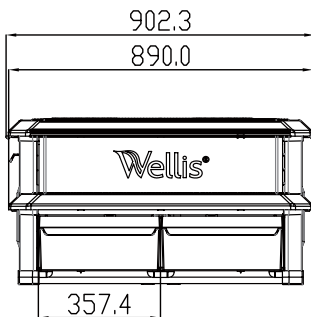
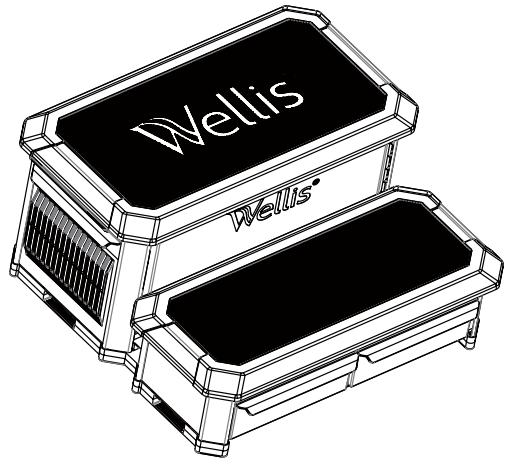
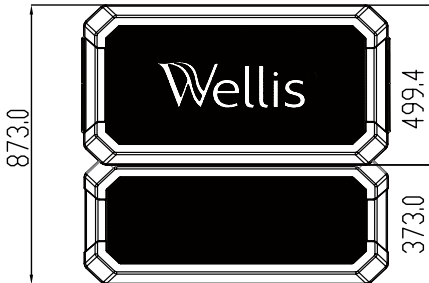

SMART STEP MANUAL (OPTIONAL)

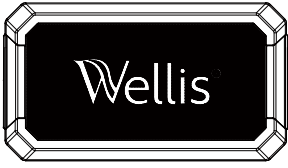

WE0135-1

1x

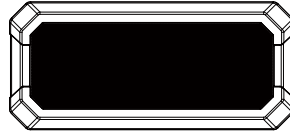

WE0135-2

1x

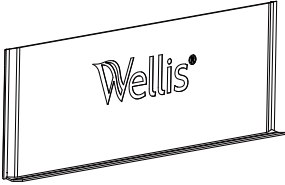

WE0135-5

1x

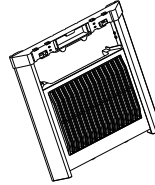

WE0135-6

1x

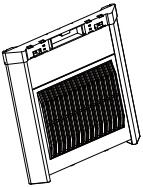

WE0135-7

1x

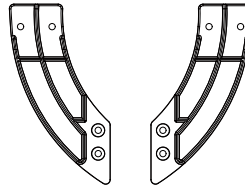

WE0135-10&11

1x

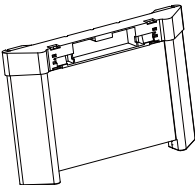

WE0135-13

2x

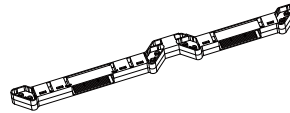

WE0135-14

2x

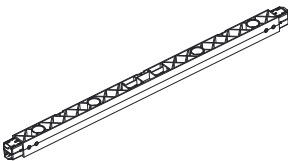

WE0135-15

11x

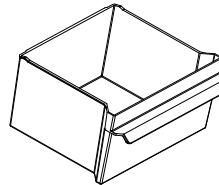

WE0135-16

2x

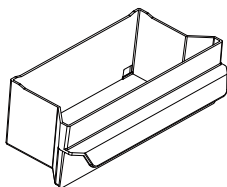

WE0135-17

1x

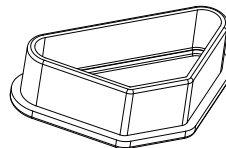

WE0135-18

8x

SMART STEP MANUAL (OPTIONAL)

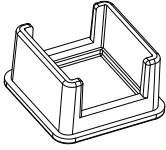

WE0135-19

5x

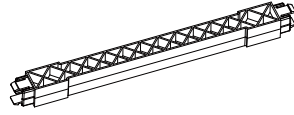

WE0135-20

2x

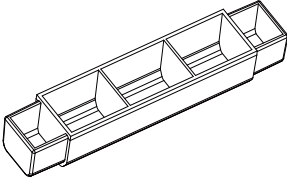

WE0135-21

2x

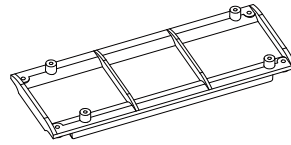

WE0135-22

2x

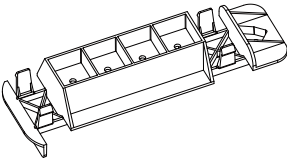

WE0135-23

2x

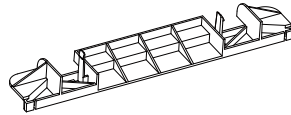

WE0135-24

2x

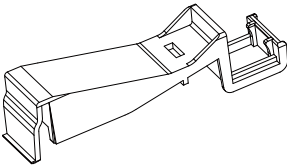

WE0135-25

6x

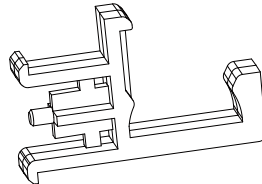

WE0135-26

8x

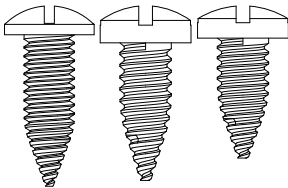

M4.2X14

16x

M3X14

4x

M3X10

16x

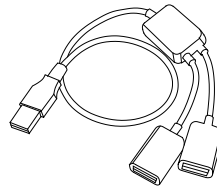

USB

1x

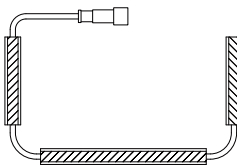

LED lights
Three paragraphs

1x

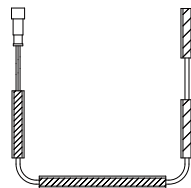

LED lights
Four paragraphs

1x

SMART STEP MANUAL (OPTIONAL)

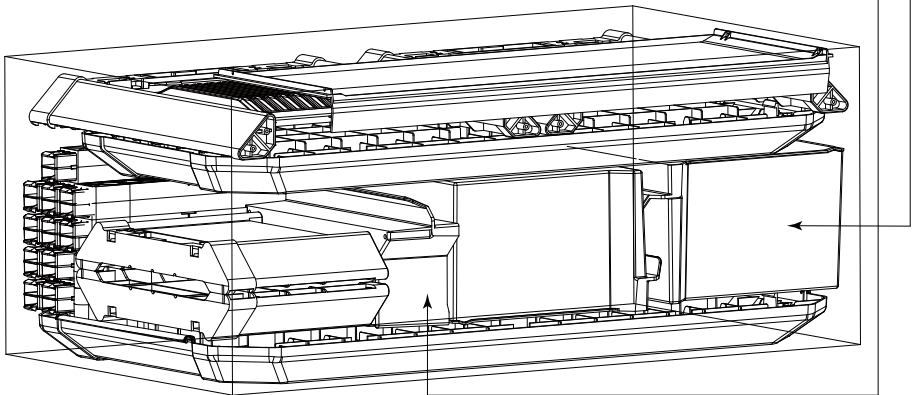
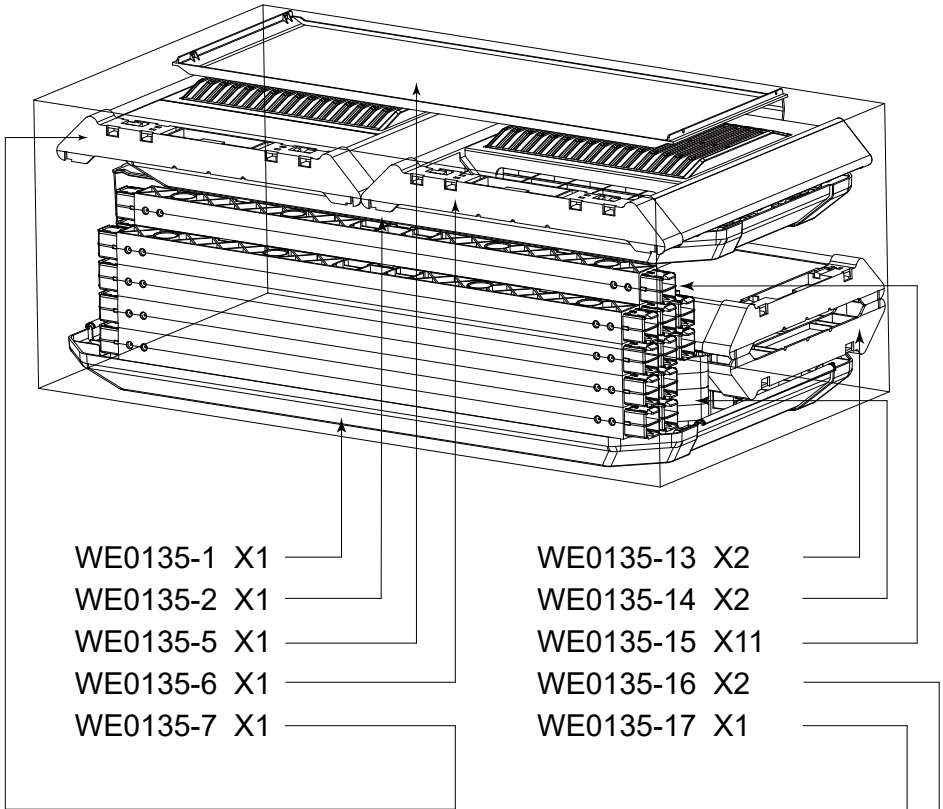

1

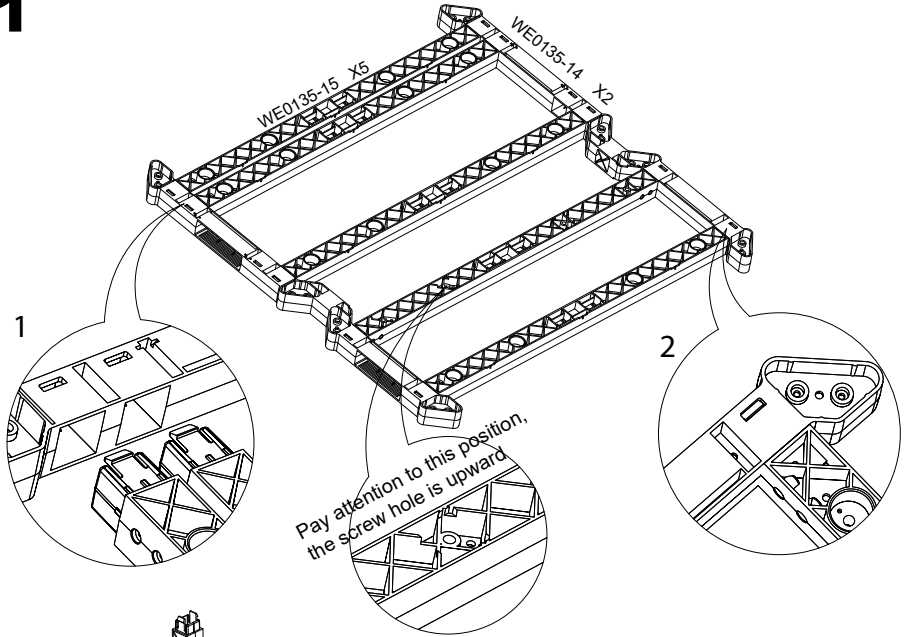

2

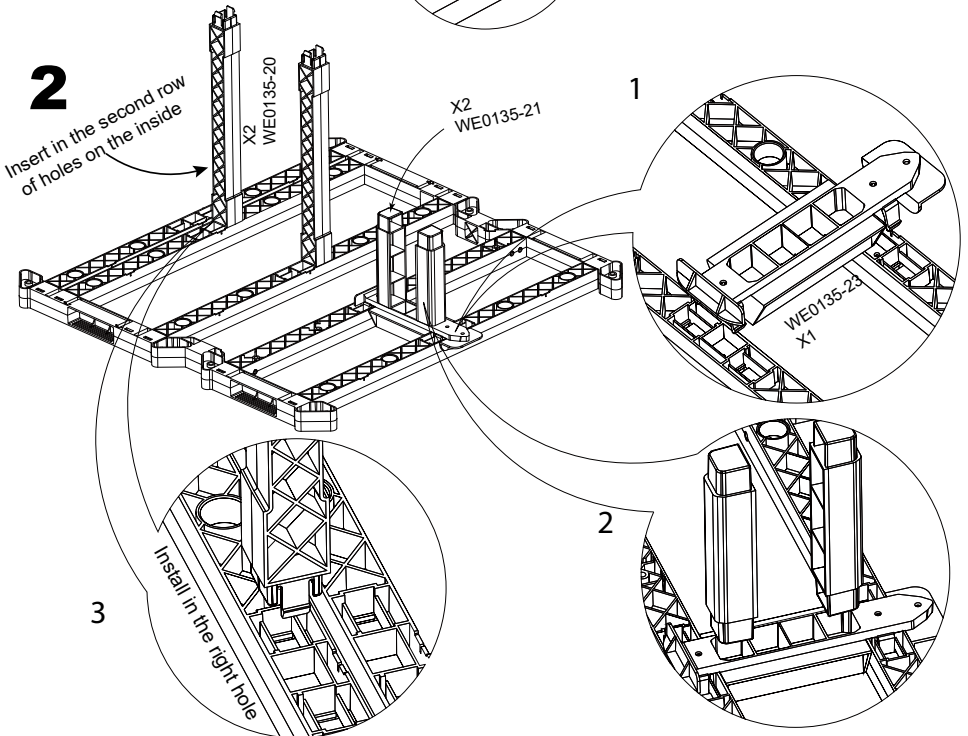

3

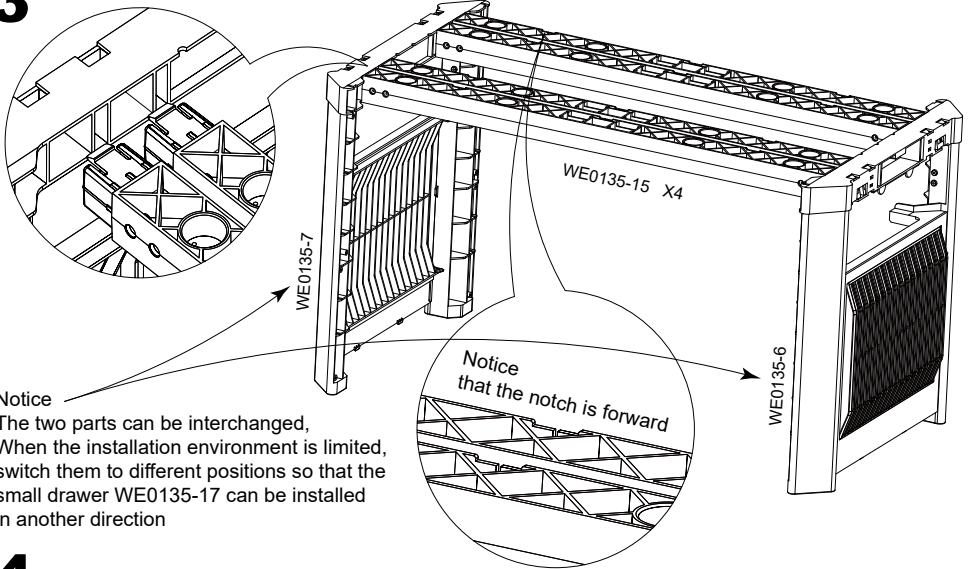

Notice
The two parts can be interchanged,
When the installation environment is limited,
switch them to different positions so that the
small drawer WE0135-17 can be installed
in another direction

4

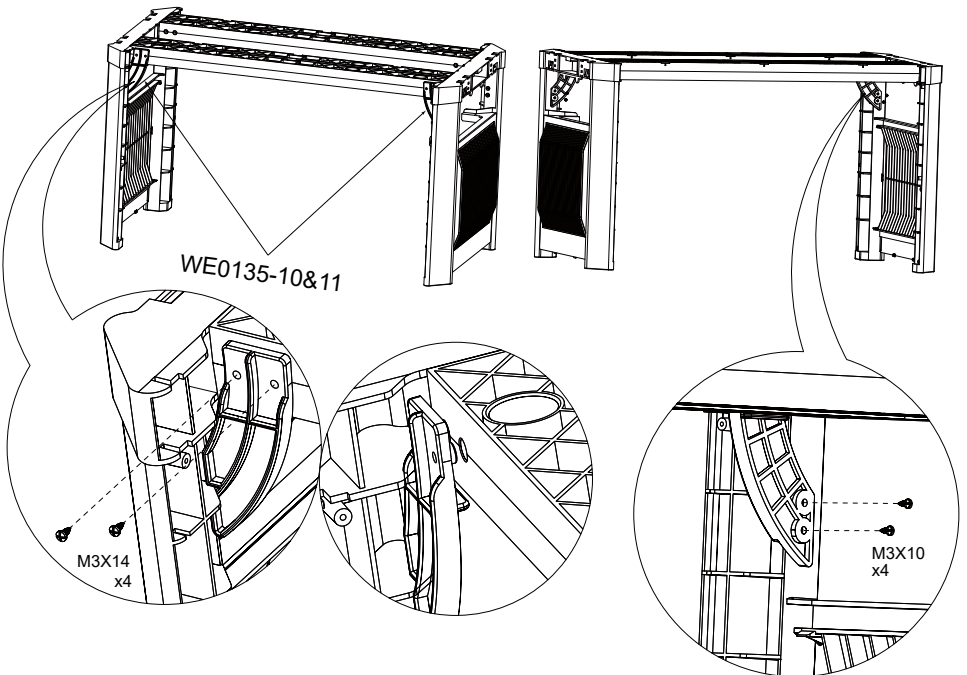

5

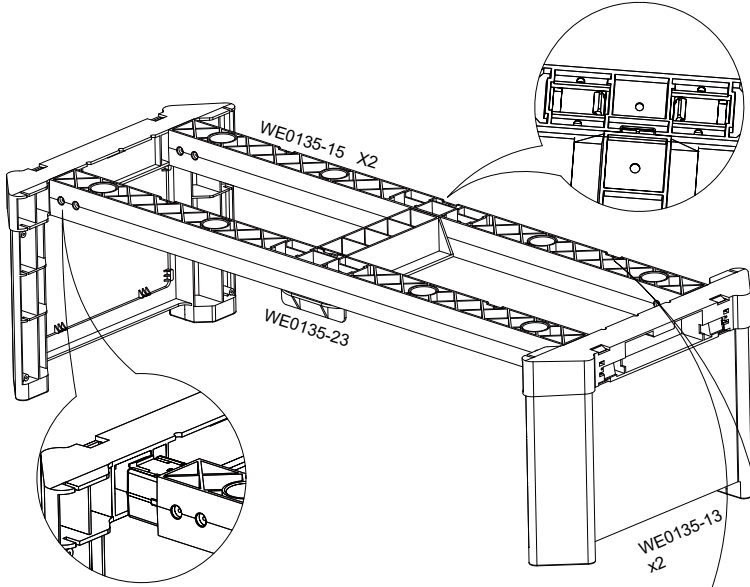

6

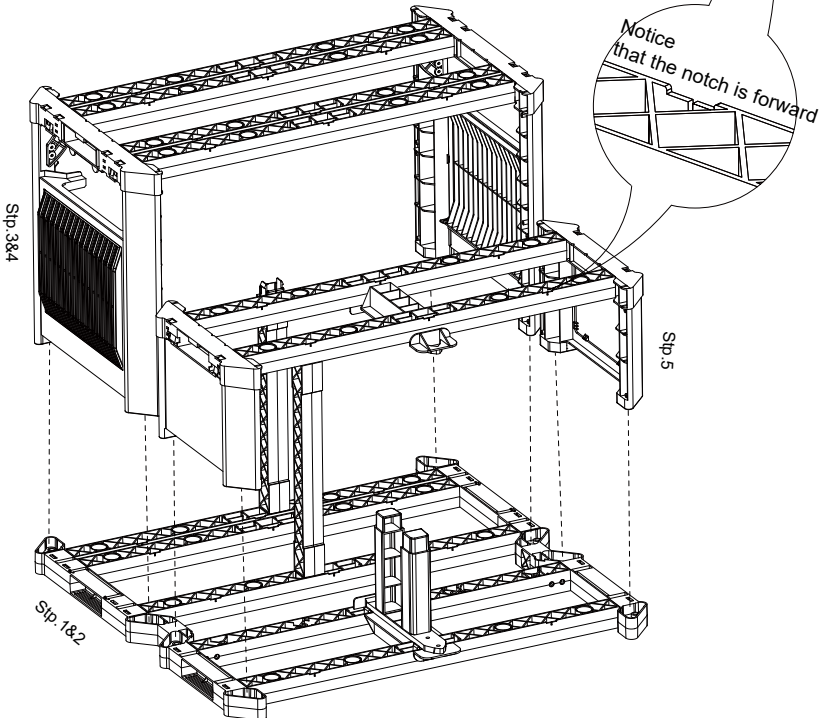

SMART STEP MANUAL (OPTIONAL)

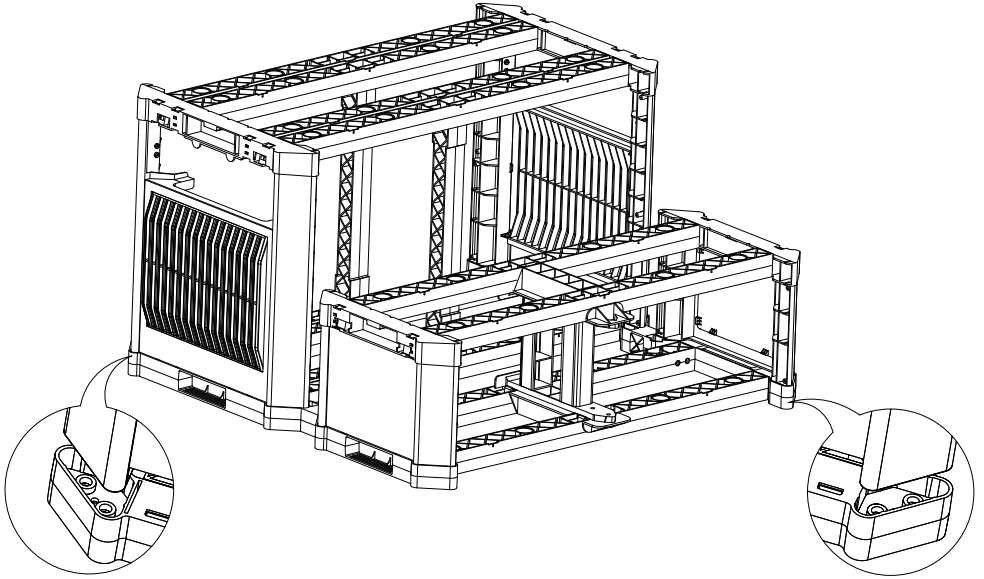

7

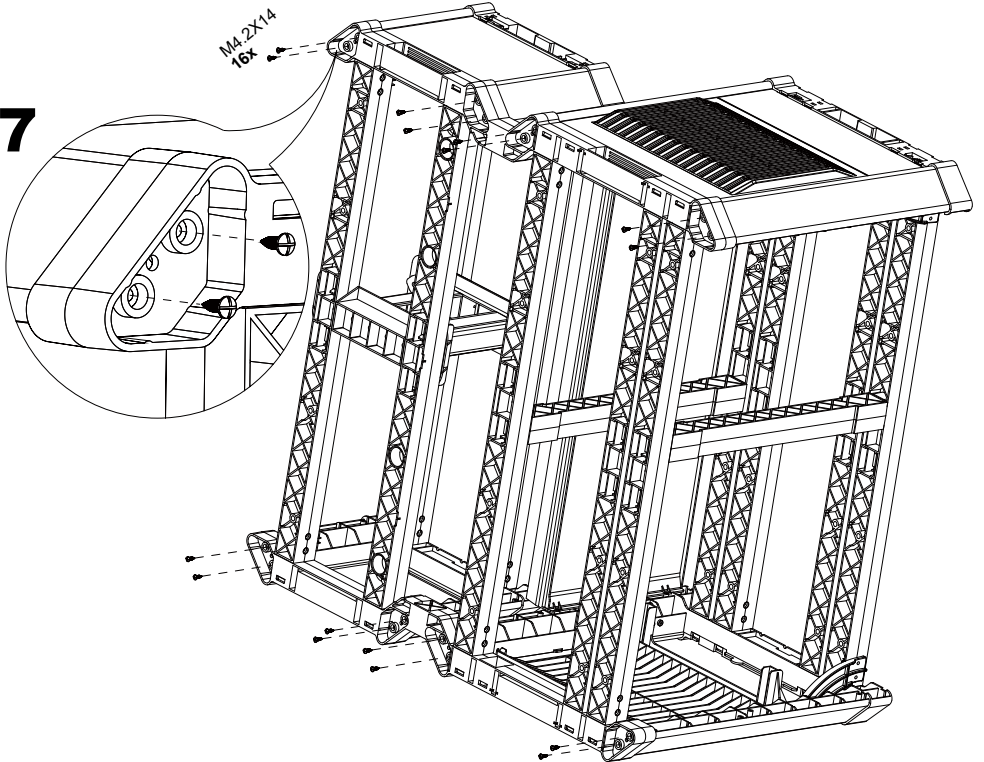

SMART STEP MANUAL (OPTIONAL)

8

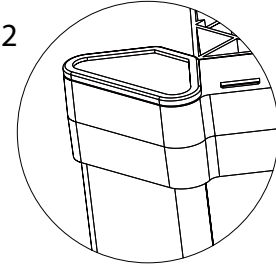
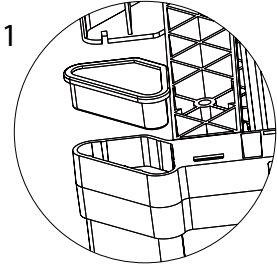
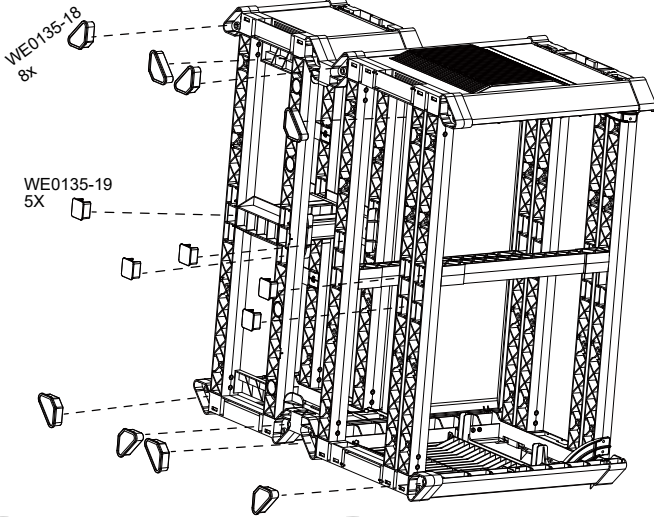

9

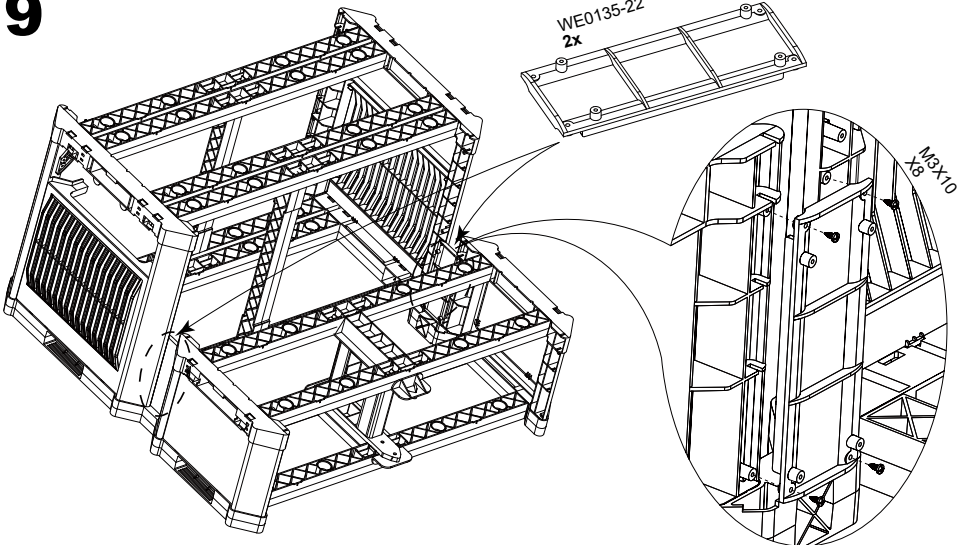

10

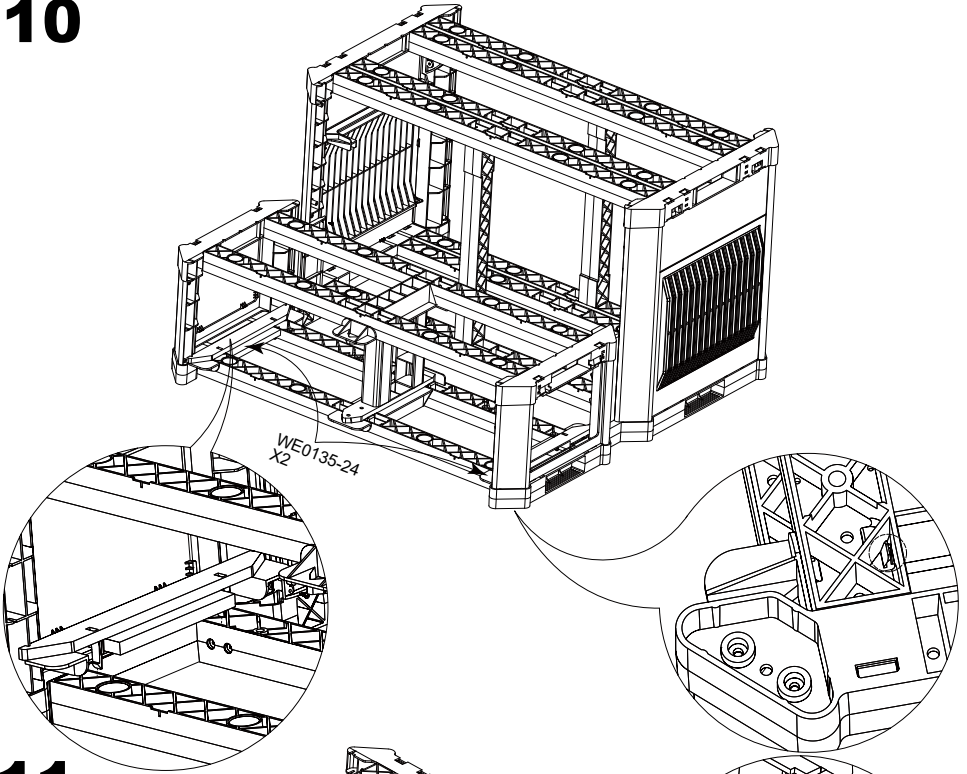

11

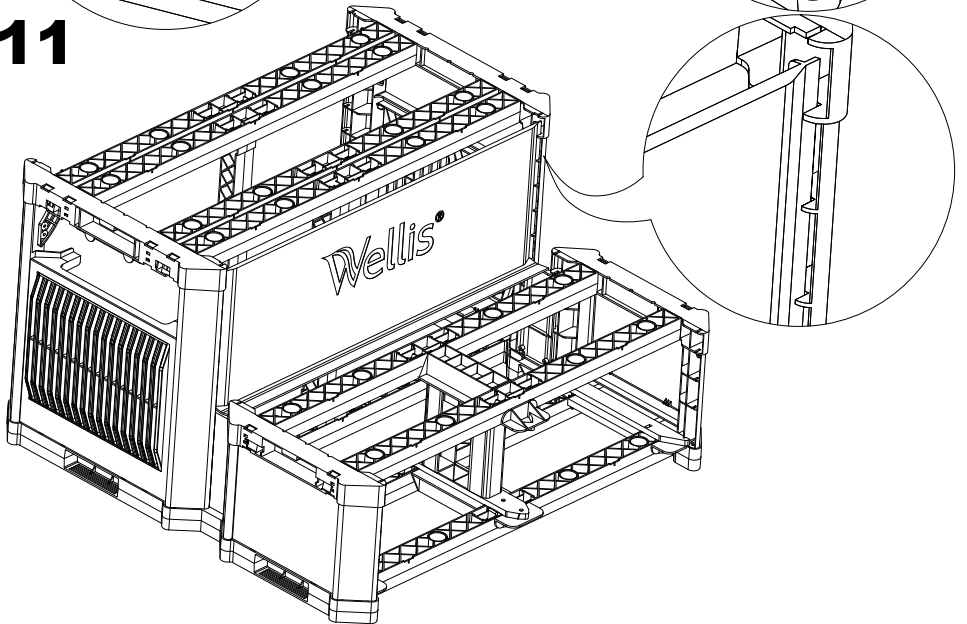

SMART STEP MANUAL (OPTIONAL)

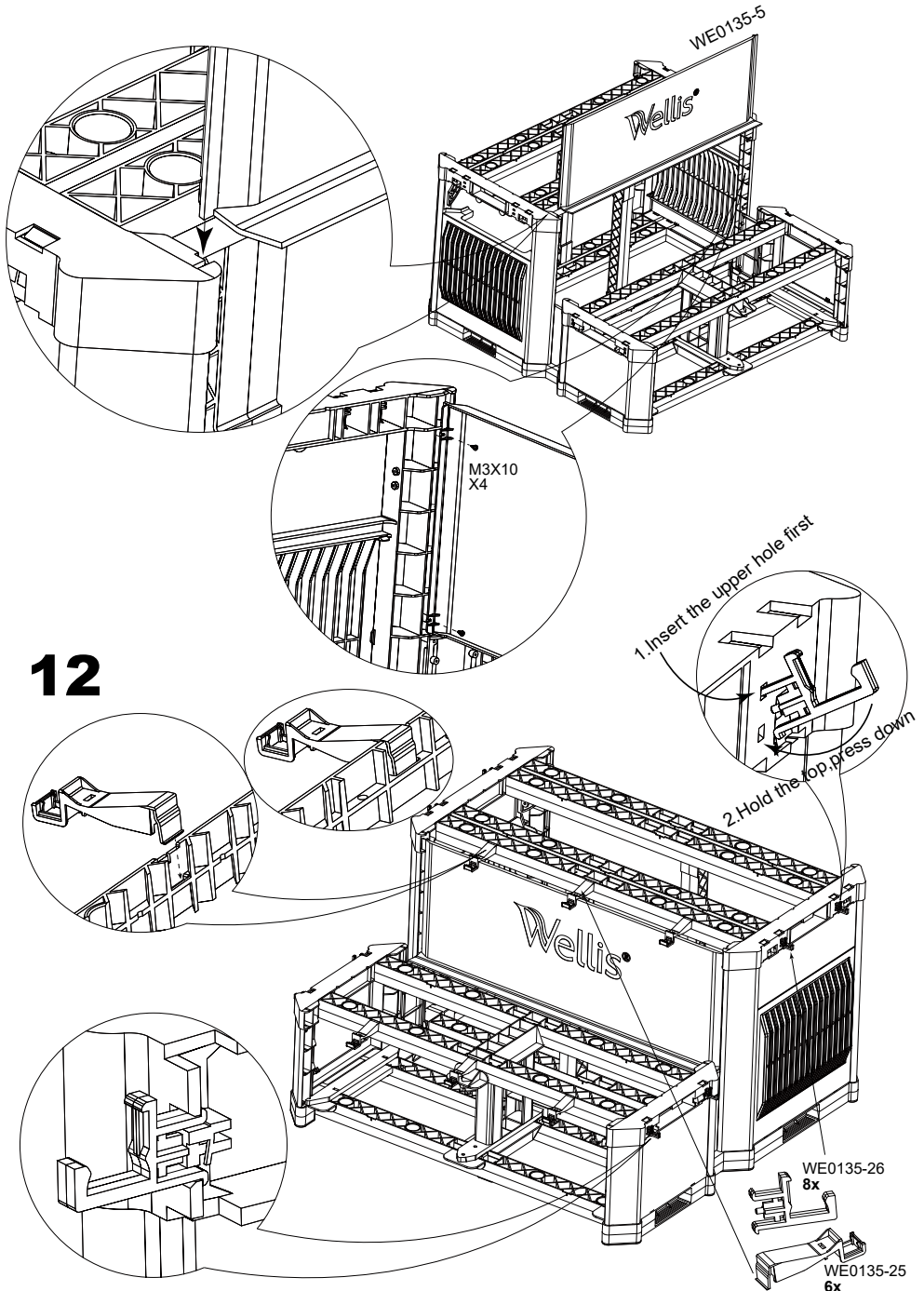

13

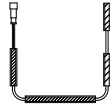

LED lights
Four paragraphs
1x

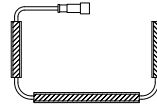

LED lights
Three paragraphs
1x

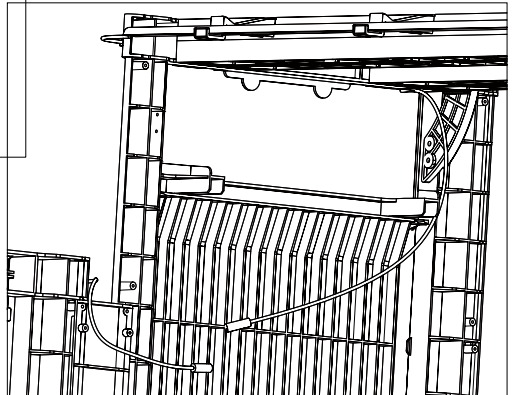
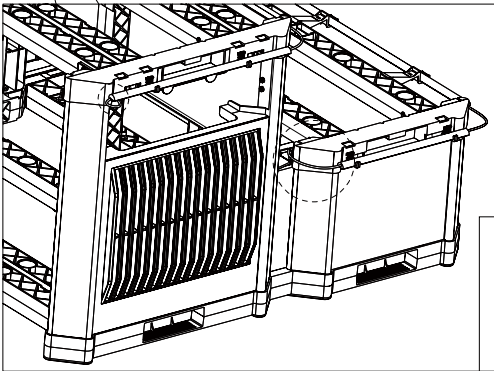
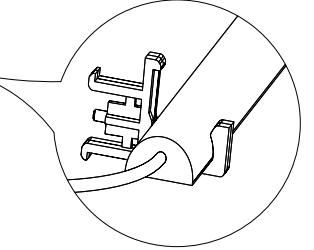
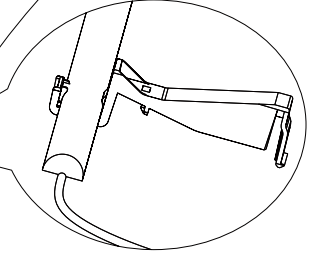
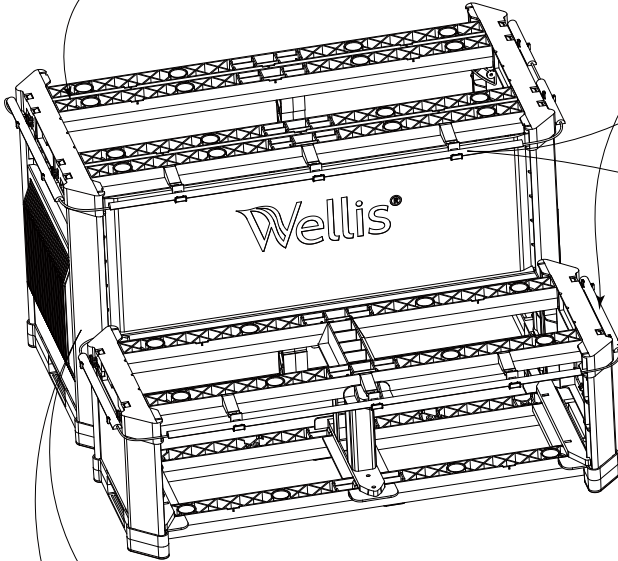

14

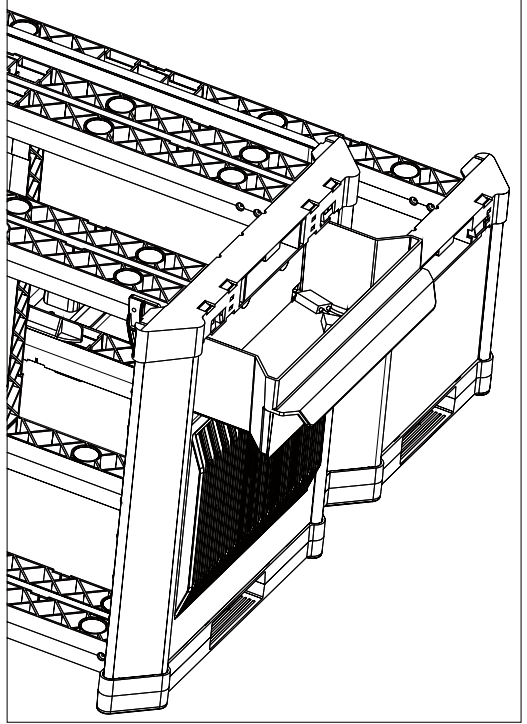
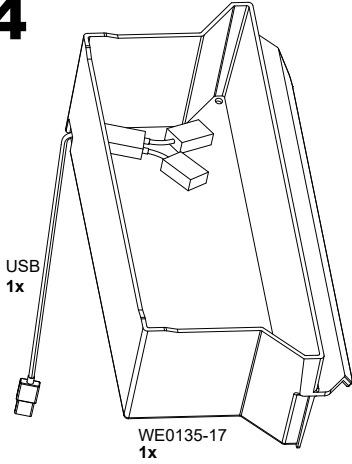

15

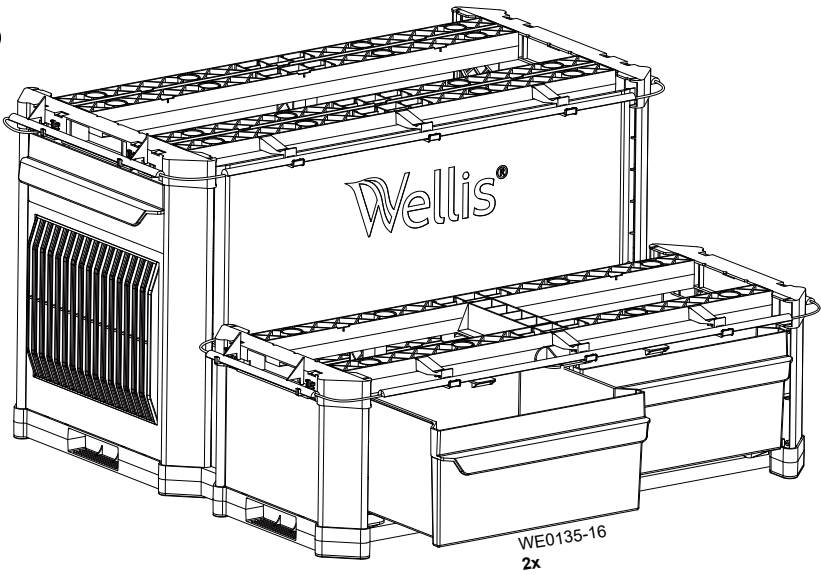

16

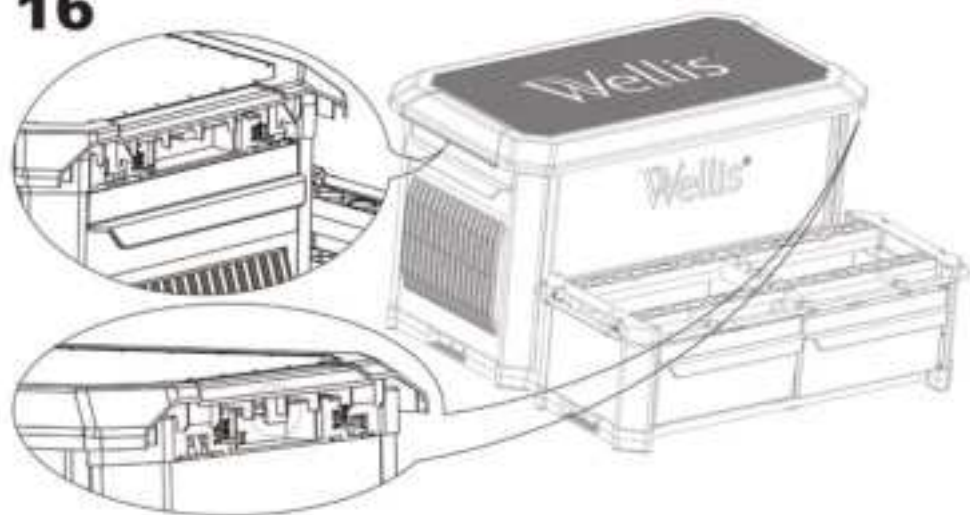

17

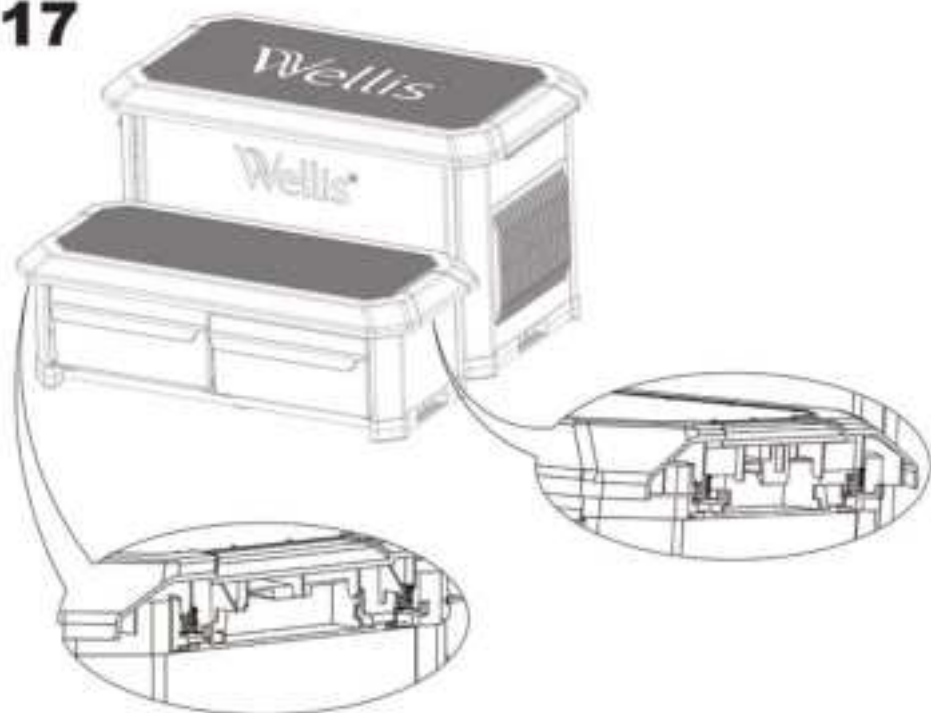

AQUASOUL PRO

AUDIO STATION FOR SPAS



Aquasoul Pro audio system offers you the perfect means to bring music into your spa. Aquasoul Pro is simple to install and compatible with numerous audio sources. For example, you may connect Aquasoul Pro to an iPod using the auxiliary audio input or play music wirelessly using a Bluetooth mobile device. Listen to music in MP3 format saved on a USB flash disk or tune in to an FM station of your choice using the Aquasoul Pro integrated FM receiver. Depending on the configuration used, Aquasoul Pro can handle up to 4 speakers and one subwoofer.

The audio station can be used to charge most mobile devices on the market with its onboard USB charger controller.

Powered with its own internal universal power supply, Aquasoul Pro can be used in any place in the world. All the electronics circuits are contained in a innovatively designed and splashproof plastic enclosure.

Aquasoul Pro is equipped with state of the art class D audio amplifiers. This type of amplifier is very power efficient and dissipates much less heat than any comparable audio system for use in spa.

Depending on the selected configuration, Aquasoul Pro conveniently lets you control music from the main keypad or may be used as a stand-alone.

Main characteristics

- Fully splashproof (IPx5)
- Integrated universal power supply
- 1 auxiliary input
- Compatible USB port
- Integrated FM receiver with external antenna
- Bluetooth receiver
- Mobile device USB charger controller
- Up to 4 speakers and one subwoofer

OTHER ACCESSORIES - AQUASOUL PRO

CONNECTIONS

PAIRING WITH A BLUETOOTH ENABLED DEVICE

Aquasoul Pro can play music from any device equipped with Bluetooth wireless technologies, however, you must pair your mobile device to the audio receiver in order to do so.

The system is ready to pair when it is not already connected to another device. To pair your device, make sure that you are close enough to the Aquasoul Pro, that it is turned on and that it is set in Bluetooth mode.

FOLLOW THESE STEPS TO PAIR YOUR DEVICE

1. Open the Bluetooth settings on your device. The location of the settings will depend on the device you are using.
2. Make sure Bluetooth is on.



3. Select "in.stream 2" in the list of discoverable Bluetooth devices detected nearby.
4. When prompted, enter 5555 as the PIN Code.



NOTE: In basic configuration (not connected to a keypad or controller), Aquasoul Pro is set in Bluetooth mode. Otherwise, please refer to your specific keypad operating manual for details on the Aquasoul Pro functions.

5. Once the pairing is done, select in.stream 2. When "connected" is displayed, Aquasoul Pro will be ready to start playing the selected audio.



Note: If the device moves out of range and loses connection, it should reconnect automatically as soon as it is close enough. This should happen without having to go through the menu again.

Aquasoul Pro will keep up to 8 devices in its memory. If one of the last three connected devices is in range and has its Bluetooth turned on, it will automatically connect to Aquasoul Pro.

If multiple devices are within range and have already been paired with Aquasoul Pro, priority will be given to the device that was first detected in the Aquasoul Pro memory.

OZMIX SYSTEM - OZONE DISINFECTION

FILTRATION AND OZONE

In a system without circulation engines the low setting of the massage engine and the ozone generator will switch on during filtration. In a circulation type system ozone starts in a system with circulation engine.

The system is factory programmed for an evening filtration cycle since energy prices might be lower in the evening

(assuming that the time of day is properly set). The filtration time and duration are programmable.

A second filtration cycle can be freely entered.

At the start of every filtration cycle the jets and engine start to clean the pipes and ensure proper water quality.



Heat Mode Operations

You can choose between four different water regulation modes available. Your in.grid is automatically detected by the spa control system at power up. It will be ready to use with your preferred heat mode one minute following power up.

The relay contacts of the in.grid will be closed if the external heating system is activated. Otherwise, the relay contacts are open.

Your desired heat mode must be set by adding a jumper on one of the five (5) different positions.

***Note:** Your heat mode selection can be changed with the in.touch 2 app on your mobile device. On your app, any new selection will override the jumper setting of the in.grid. The in.touch 2 app will automatically detect the in.grid presence and will adapt its menu configuration as required.

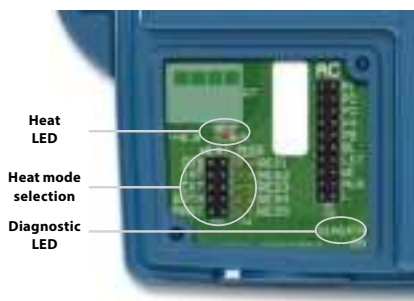

Five available heat modes are offered with in.grid:

1- DIS (DISABLED)

Use this mode if the spa configuration does not have any external heating system and only the single switch functionalities are used. This will avoid in.touch 2 application on a mobile device to display the Heat Mode Selection menu*. The spa controller will regulate the water temperature using the standard resistive heater. The single button switches will control the different spa accessories according to the AC jumper selections.

IMPORTANT: This mode can only be set with the heat mode jumpers.

2- INT (INTERNAL)

This mode provides an easy way to revert back to standard water regulation using the internal heater in case of problem with the external heating system.

3-EXT (EXTERNAL)

Use this mode for a maximum energy saving purpose. The spa control system will only use your external heating system to regulate the water temperature. In normal operation, the internal heater will never be activated.

Freeze Protection

Freeze protection has been added because EXT (EXTERNAL) mode does not allow the activation of the internal heater. In cold weather, if it becomes impossible to keep the water over freezing point, the help of the internal heater will then be needed. This is the only time the freeze protection will come in.

At any time, if the water temperature drops to 40°F (4.5°C), the resistive heater will give a boost to avoid freezing. The freeze protection will stay active until water temperature reaches the minimum allowed set point (usually 59°F / 15°C). Normal EXT mode will resume functioning thereafter.

4- BOTH (BOTH SYSTEMS ALL AT ONCE)

The spa control system will always use the external heating system AND the internal heater simultaneously to regulate the water temperature; they are both activated or deactivated at the same time.

5- SMART (ENERGY SAVINGS)

The spa control system will always use the external heating system to regulate the water temperature. If the temperature falls too far below your set point (-2.5°F), the internal heater will be activated to help your external heating system reach the set point.

Troubleshooting

DIAGNOSTIC LED

The diagnostic LED will help you with the status of the connection between the spa control system and the in.grid.

Blinking light: Spa control system not detected, not compatible or in Disable mode if one of your single switches doesn't operate properly.

Solid light: Spa control system detected

No light: Power Off

HEAT LED

Solid light: Relay contacts close and external heating system on.

No light: Relay contacts open and external heating system off.



in.touch 2

Easily integrate your spa to the Internet of Things!

Simplest of setups

in.touch 2 eliminates all the complexities of connecting your spa to the Internet and transforms your smartphone or tablet into your ultimate Wi-Fi spa remote control. in.touch 2 comes with a state-of-the-art app and 2 prepared radio frequency transmitters, one being part of your spa system and the second one being connected to your Internet router. Both RF transmitters are prelinked to one another, enabling an immediate and perfect communication between you and your spa.

Strong and long range communication signal

Through their proprietary RF technology, in.touch 2 transceivers emit a strong, stable and long range signal between your spa and your router (about 3 times longer than regular Wi-Fi signal). No need for repeaters or boosters: your spa will always remain within reach in typical backyard settings.

State-of-the-art app with push notifications

in.touch 2 streamlined application makes it very easy to control and program all the functions and features of your spa from your smartphone or your tablet. Even when you're away from home, you get full control of your water care settings, filtration cycles, water temperature, economy modes and a lot more. Push notifications will always keep you informed on the status of your spa, even when your app is not open.

in.touch 2 overview

Home Transmitter (EN Module)

Spa Transmitter (CO Module)

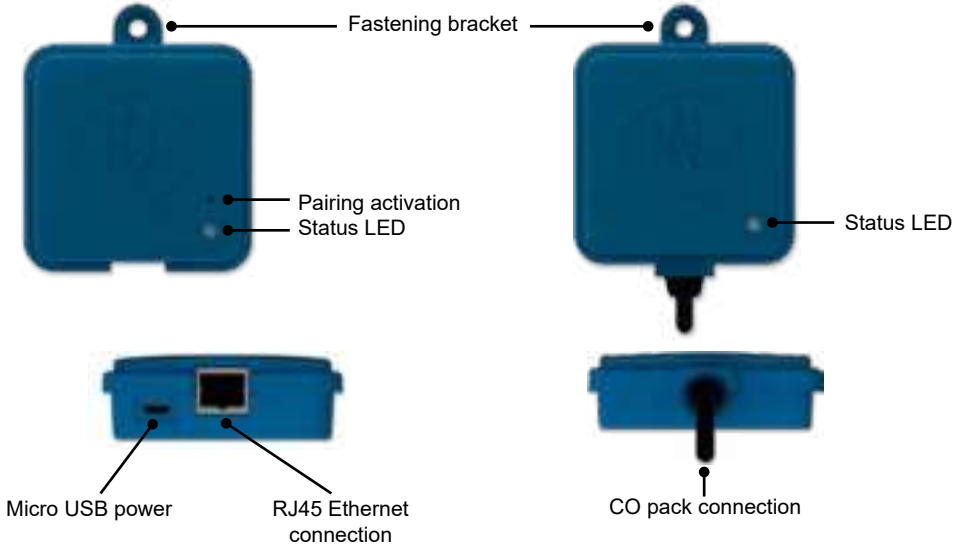

in.touch 2 dimensions

Home Transmitter (EN Module)

Spa Transmitter (CO Module)

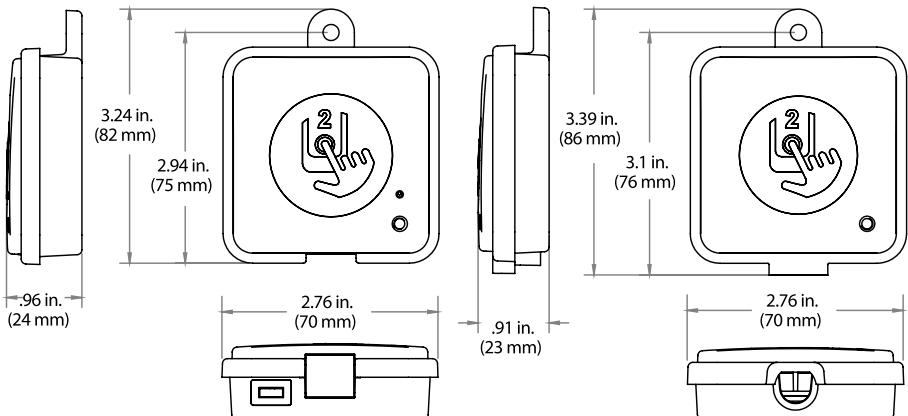

Home Transmitter (EN Module) installation

The Home Transmitter unit must be installed inside the house near the router as it needs to be connected to it. The Home Transmitter is provided with an Ethernet cable and a power supply. If required, a longer cable of good quality can be used by the installer (longer cable not provided) to install the Home Transmitter closer to the spa within the home.

The only requirement for installation location is that household .current be available to power the Home Transmitter using the provided wall transformer.

The Home Transmitter can be fixed in the house to optimize the signal strength. We recommend that you install the unit with a #8 pan head screw.

Here are some suggestions for a successful installation:

- If possible, install device on the first floor of your house.
- If installing in a basement, place at highest level possible and closest to a window.
- Try to install as far as possible from materials that may interfere with signal (ie. metal structures, thick cement walls).
- Install as far as possible from router as the signal emitted by the antenna may interfere with RF signal.



Connection of the Home Transmitter (EN Module)

Simply connect Ethernet cable into the RJ45 port of the Home Transmitter and in one of the available LAN ports on the router.

Finally, to power up the Home Transmitter, connect the provided transformer to a 120V (North American model) or 220V (European model) household supply and connect the USB cable between the transformer and the Home Transmitter.

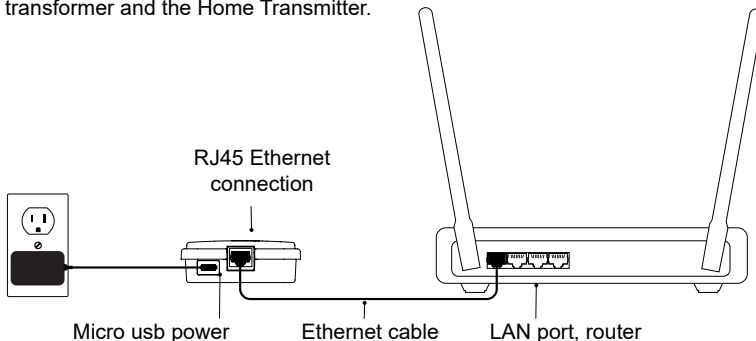

Pairing the Spa Transmitter (CO Module) and the Home Transmitter (EN Module)

The pairing process is used when you need to replace one module of the in.touch 2 kit. Otherwise, the in.touch 2 arrives pre-paired from the factory.

1. Power up the Home Transmitter

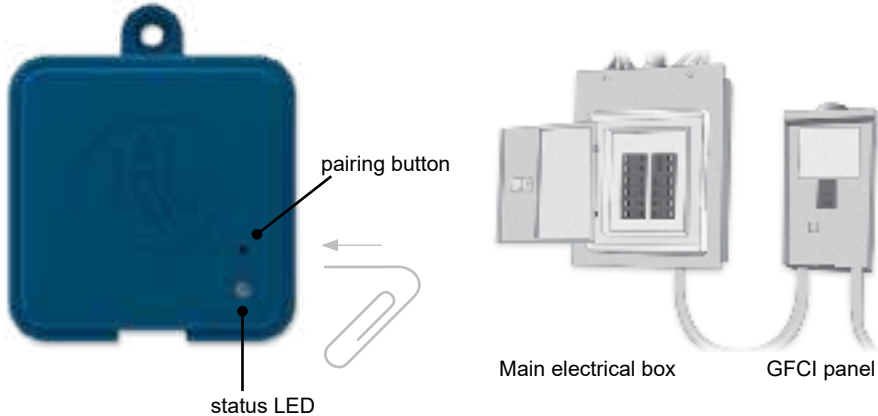

- Press on the pairing button with a paper clip or some similar tool. When the pairing mode is active the status LED flashes YELLOW in a rapid pattern. The Home Transmitter is then in pairing mode and will remain in this mode until it pairs with an Spa Transmitter, or until it is reset (power cycled).
- Shut off the spa's breaker (thus turning off the Spa Transmitter), wait a few seconds, and then flip the breaker back on. Within a few seconds, the pairing operation should complete and the Home Transmitter status LED will no longer be YELLOW.

Note: in.touch 2 modules can be paired as often as necessary, but can only be paired with a single counterpart module at a time. Once paired, the modules store this information permanently until the next pairing operation. Pairing information is stored in non-volatile memory, so pairing is not required after a power failure. Only a Home Transmitter can initiate a pairing, so it is important that the pairing begin with putting the Home transmitter module in pairing mode.

If several spas are powered up at the same time with a Home Transmitter in pairing mode (for instance, in a dealer showroom), only the 1st spa to successfully connect to the Home Module will pair. As this can be random, it is recommended that only 1 spa be powered up at a time during the pairing process.

LED

Each in.touch 2 module has a status LED that can be used for troubleshooting purposes. The LED is located on the top of both enclosures.

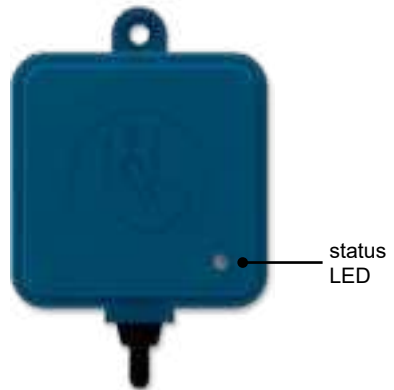
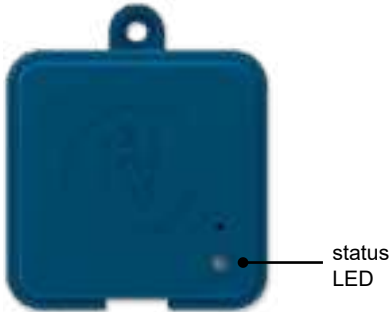

Home Transmitter

Pairing mode Yellow (Blinking)	●
Router not detected	●
Router detected	●
in.touch 2 server detected	●
Module is fully functional	●

Spa Transmitter

Pairing mode Yellow (Blinking)	●
Spa controller not detected	●
in.touch 2 server detected	●
Module is fully functional	●

** When the LED status is blinking (blue, green or red) this indicates that the communication between the EN module and the CO module it not established.*

Download application



The in.touch app allows you to control your spa using your home network or an Internet connection anywhere in the world. The Wellis Spa Control (in.touch 2) app is waiting for you in the App Store for iOS devices and on Google Play for Android — search for «Wellis Spa Control» then click on it to install.

Use this application

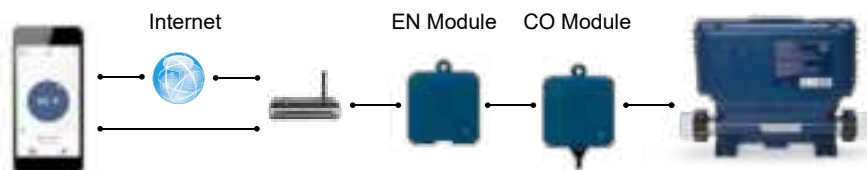

On your home network

It is possible to access your spa with the in.touch 2 app through your home network. To be able to see your in.touch 2 in the application you need to connect your device to the same router (Wi-Fi network) than the one used to connect your Home Transmitter

Go to the Wi-Fi settings section of your mobile device and choose the same network that your spa is connected to (i.e. Home). Once you've selected it, wait until your device confirms the connection.

On the Internet

The in.touch 2 allows you to use the Internet to control your spa from anywhere in the world. In order for them to communicate, both the in.touch 2 module and your device must be connected to a network that allows access to the Internet.

Once your Home Transmitter is connected to the Internet (the LED status is blue), you can use your in.touch 2 app any time your device is also connected to the Internet (wireless or cellular network), even if you are away from home.

To have access to your spa away from home, you will need to have previously linked your mobile device to your spa on your home network.

Setup your Wi-Fi on your device



Before using your application, go to the Wi-Fi section of your device's settings. Make sure you are connected to your home network. This needs to be the same Wi-Fi provided by the router to which you connected your Home Transmitter.

Start the Wellis Spa Control application



Find the icon for the in.touch 2 application, then tap on it to open it.

The first time you use the application a message will ask you: "in.touch 2" Would like to send you notifications. If you choose Allow, the application will send you notifications about the status of your spa. If you choose Don't Allow, the application will not send you notifications.

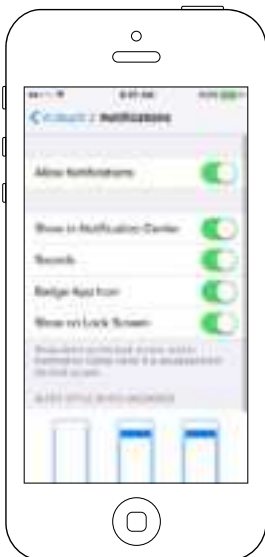

If you change your mind later concerning notifications, you may add or remove notifications for the in.touch 2 application.

On iOS, go in your settings menu and choose in.touch 2. Select the notifications menu, you can turn notifications on or off from this page.

On Android, go to your settings menu and then into the notifications menu. Select the in.touch 2 app, from this page you may turn notifications on or off.

Login page



Before using your application, you must create an account first and then, you'll be able to sign in. Your account will give you the opportunity to have access to your spa from any in.touch 2 application.

New account creation



When you choose to create a new account, you agree at the same time our Terms of Service and our Privacy Policy. You can read them at any time through this link:
<https://geckointouch.com/legal>

Choose a spa







This page displays all the spas detected by your application.

To detect your spa, you need to connect your mobile device to the same network to which you connected your Home Transmitter.

Once you have done a connection with the spa its name will be saved on this page to allow you to connect to this spa from anywhere.

To add a spa later on, go to p. 26 of this techbook for instructions. The RF signal strength (communication between the two in.touch 2 transmitters) is illustrated on the Select a spa page. There are 5 possible states:

-  • Signal superior to 80%
-  • Signal between 80% and 51%
-  • Signal between 50% and 31%
-  • Signal below 30%
-  • The Spa Transmitter is not available

Home page

The main screen gives you access to your accessories, water temperature, water care and settings.

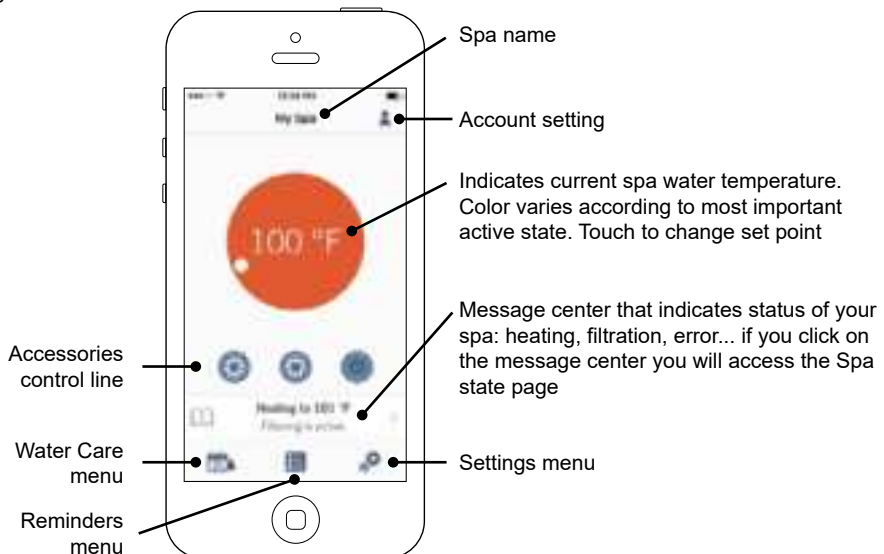

Spa state



This page displays all the active states of your spa. Below is a quick description of each state you may encounter on your spa. Each state is associated to a priority and color that determines the color of the widget on the home page.

- Indicates that there is an error on your spa.
- Indicates that there is presently an active user demand on your spa (ie. pump, blower or light is on).
- Indicates that your spa is now heating to your set point.
- Indicates that your spa is now in a filtering cycle.
- Indicates that your spa is now in economy mode.
- Indicates that your spa is running normally (there is no user demand, heating, no filtration or economy active).

The widget on the home page displays a single color at a time. The color displayed is decided by priority of state. The established priority is as listed above.

Change temperature

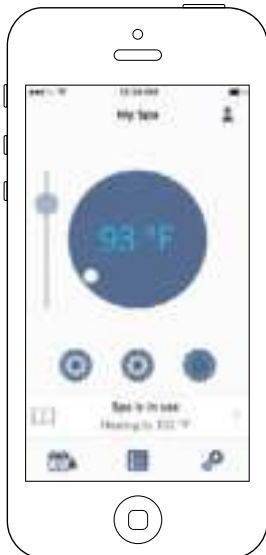

Touch the centered widget to reveal the temperature control bar.

Use the slider on the control bar to change your spa's temperature* set point.

** If you are in economy mode your spa temperature will be 20°F below your set point.*

Turn on/off accessories



According to your spa pack configuration, you can start or stop an accessory by simply touching the associated icon. The icon will become animated when the accessory is on. Simply press on the icon to start or stop the accessory.

If your accessory has more than one speed, press the button until the desired speed is reached.

The icon designs are customized according to your spa pack configuration:



Turn on/off the lights



To control your spa lights, simply press the button to turn it on or off

Control your in.mix 300

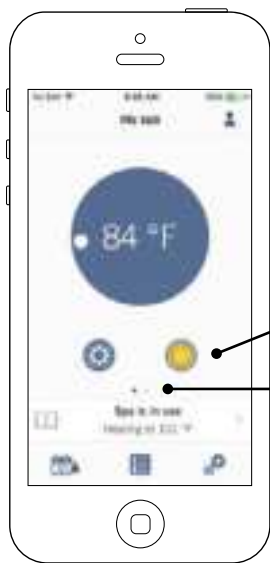

This menu is only available if an in.mix 300 is detected in your spa accessories

To turn on or off the in.mix 300, you can use, if you want, the light icon on your home page. To go to your in.mix 300 page, simply swap to the left.

Turn on/off in.mix 300

Swap to in.mix 300

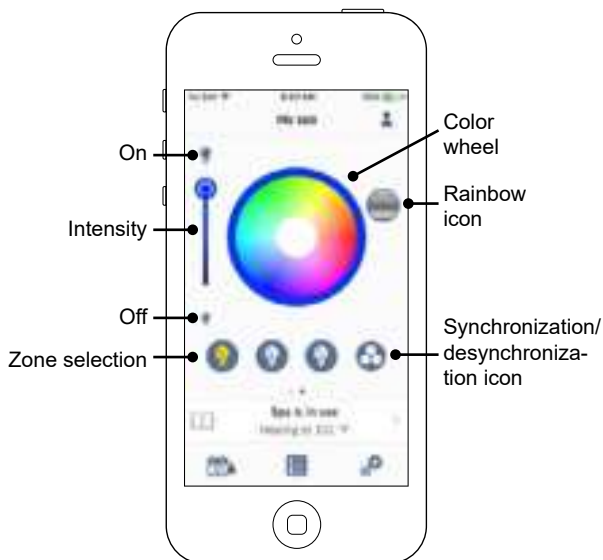

The in.mix 300 page allows you to customize your color zones in or around your spa.

The light bulb icons allow you to turn on and off your in.mix 300.

To select a zone, click on the wanted one in the “zone selection” stripe. To change the color, use the color wheel to choose the one you want. On the left side, the intensity slider allows you to modify the brightness of your lights. Use the rainbow icon to get color gradation.

The synchronization / desynchronization icon gives you the possibility to match the color of the selected zone with the other zones

Water Care

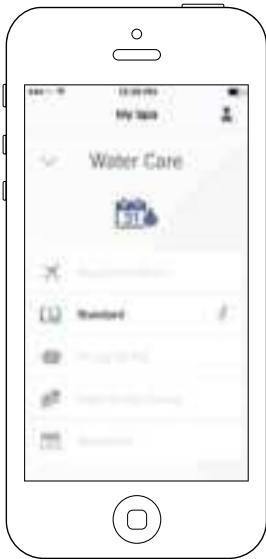

The Water Care page will help you set up your ideal filtration and heating settings. Choose between Away from Home, Beginner, Energy Savings, Super Energy and Weekender, depending on your need. Touch the Water Care name you would like to activate, a green checkmark will appear on the icon, indicating you have selected it.

By default, each Water Care mode has pre-configured schedules of economy and filtration. To modify Water Care options, touch the pencil icon at the right end of the desired Water Care to open its menu.

Below you have a short description of each Water Care at default state:



Away From Home:

In this mode the spa will always be in economy; the set point will be reduced by 20° F.



Beginner / Standard:

The spa will never be in economy mode and will be filtering according to the pack's low level configuration.



Energy Savings:

The spa will be in economy mode during the peak hours of the day and resume normal mode on the weekend.



Super Energy Savings:

The spa will always be in economy mode during peak hours, every day of the week.



Weekender:

The spa will be in economy mode from Monday to Friday, and will run normally on the weekend.

Reminders



Reminders page will help you to make a follow-up of your maintenance.

The in.touch 2 will remember you to perform required maintenance tasks on your spa, such as rinse filter or clean filter. Each task has its own reminder duration based on normal use. The owner can reset his reminders after the spa maintenance.

Modifying schedules



In this menu it is possible to add, remove or edit schedules of economy or filtration.

To have access to this menu, simply touch the tabs:
Water Care menu - the little pen at the right of the wanted water care

Touch the Economy tab to modify the economy schedules and Filter cycle tab for the filtration schedules. You can add economy or filtration schedules by touching the « + » symbol.

To delete a schedule, touch the garbage can icon at the right end of the desired line.

You can modify the programmed schedules by selecting one and adjusting the schedule.

You have several possibilities for the schedule (Mon-Fri, weekend, every day, or single days). The schedules will be repeated weekly. The time and duration are set in 30 minute increments. Once you have set the schedule, use the arrow at the top of the page to go back. Ensure that you have selected the desired Water Care mode in the main Water Care menu.

When an economy schedule is active, the set point will be reduced by 20°F, which means that the heating system will not be engaged unless the temperature falls to 20°F below the spa's set temperature.

The filtration schedule is applied to the main filtration pump, most likely pump 1. If your spa uses a circulation pump configured to run 24 hours, the screen will show purge schedules instead of filtration. The purges are pre-programmed for a fixed number of minutes, therefore the duration will be set to N/A on the screen and only the start time can be modified.

Spa Settings



In the Settings page you can access the following:

- *in.touch network*
- *Temperature units*
- *Change spa name*
- *Technical info*

To select an item, tap on the arrow next to it. It will open the selected menu.

in.touch network



The in.touch network menu allows you to have access to information concerning the RF connection parameters between the Home Transmitter and the Spa Transmitter. This menu gives you access to:

- Channel
- Signal strength
- Reset channel (resets channel to ... default)

To change channels, press on the Channel line.

Change channel



The Change channel page allows you to change the channel used by the two in.touch 2 modules.

In some cases, this can help you to have a stronger signal.

You can have access to this page by touching the following tabs: Spa settings (at the bottom right) - in.touch network - channel

Temperature units



This menu lets you change the units used to display temperature.

You can have access to this page by touching the following tabs: Spa settings (at the bottom right) - temperature units.

Name



This section allows you to edit the name of the spa.

You can have access to this page by touching the following tabs: Spa settings (at the bottom right) - Change spa name

Technical Info



This section shows information about the in.touch 2 software number and the revision numbers of the different components of your system.

You can have access to this page by touching the following tabs: Spa settings (at the bottom right) - Technical info

Settings



In the Settings page you can access the following:

- *Add a spa from local network*
- *Account*
- *Tutorial*
- **Legal*
- ***Patents*

To select an item, tap on the arrow next to it. It will open the selected menu.

*The button Legal will bring you to this web site :
<https://geckointouch.com/legal>

**The button Patents will bring you to this web site:
<http://geckoportal.com/corpo/#patents>

Add a spa



This page displays all the spas detected by your application.





To detect your spa, you need to connect your mobile device to the same network to which you connected your Home Transmitter.

Once you have done a connection with the spa its name will be saved on this page to allow you to connect to this spa from anywhere.

You can have access to this page by touching the following tabs: Settings (up right corner) - Add a spa

The RF signal strength (communication between the two in.touch 2 transmitters) is illustrated on the Select a spa page.

There are 5 possible states:

-  Signal superior to 80%
-  Signal between 80% and 51%
-  Signal between 50% and 31%
-  Signal below 30%
-  The Spa Transmitter is not available

Account



This section gives you access to your account information.

You can have access to this page by touching the following tabs:
Settings (up right corner) - account

Tutorial



This section gives you a quick overview of your in.touch 2 application's functions.

Technical Support invitation



When you receive an invitation for Technical Support, a red circle will be displayed next to the “setting” logo (top right corner).

Authorizing an invitation



All the invitations you may receive are under the dealers tab in the “settings” menu.

To choose an invitation, simply click on it. You will then see a window authorization to confirm with the dealer's information.

You can also decline the invitation at any time if you want to.

Dealer page



Once you've had a dealer on your in.touch 2 app, you can, at all times, have access to his information.

If you don't want your dealer to have access to your spa anymore, simply swap to the left the "Allow access to your spa" button at bottom of the page.

Heat Mode Operations

You can choose between four different water regulation modes available. Your in.grid is automatically detected by the spa control system at power up. It will be ready to use with your preferred heat mode one minute following power up.

The relay contacts of the in.grid will be closed if the external heating system is activated. Otherwise, the relay contacts are open.

Your desired heat mode must be set by adding a jumper on one of the five (5) different positions.

**Note: Your heat mode selection can be changed with the in.touch 2 app on your mobile device. On your app, any new selection will override the jumper setting of the in.grid. The in.touch 2 app will automatically detect the in.grid presence and will adapt its menu configuration as required.*

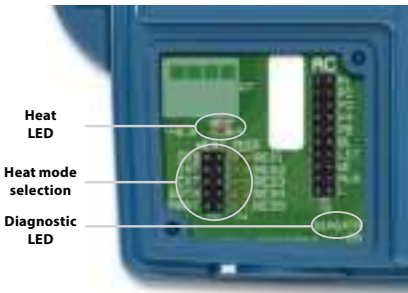

Five available heat modes are offered with in.grid:

1- DIS (DISABLED)

Use this mode if the spa configuration does not have any external heating system and only the single switch functionalities are used. This will avoid in.touch 2 application on a mobile device to display the Heat Mode Selection menu*. The spa controller will regulate the water temperature using the standard resistive heater. The single button switches will control the different spa accessories according to the AC jumper selections.

IMPORTANT: This mode can only be set with the heat mode jumpers.

2- INT (INTERNAL)

This mode provides an easy way to revert back to standard water regulation using the internal heater in case of problem with the external heating system.

3- EXT (EXTERNAL)

Use this mode for a maximum energy saving purpose. The spa control system will only use your external heating system to regulate the water temperature. In normal operation, the internal heater will never be activated.

Freeze Protection

Freeze protection has been added because EXT (EXTERNAL) mode does not allow the activation of the internal heater. In cold weather, if it becomes impossible to keep the water over freezing point, the help of the internal heater will then be needed. This is the only time the freeze protection will come in.

At any time, if the water temperature drops to 40°F (4.5°C), the resistive heater will give a boost to avoid freezing. The freeze protection will stay active until water temperature reaches the minimum allowed set point (usually 59°F / 15°C). Normal EXT mode will resume functioning thereafter.

4- BOTH (BOTH SYSTEMS ALL AT ONCE)

The spa control system will always use the external heating system AND the internal heater simultaneously to regulate the water temperature; they are both activated or deactivated at the same time.

5- SMART (ENERGY SAVINGS)

The spa control system will always use the external heating system to regulate the water temperature. If the temperature falls too far below your set point (-2.5°F), the internal heater will be activated to help your external heating system reach the set point.

Troubleshooting

DIAGNOSTIC LED

The diagnostic LED will help you with the status of the connection between the spa control system and the in.grid.

Blinking light: Spa control system not detected, not compatible or in Disable mode if one of your single switches doesn't operate properly.

Solid light: Spa control system detected

No light: Power Off

HEAT LED

Solid light: Relay contacts close and external heating system on.

No light: Relay contacts open and external heating system off.

in.grid Heating Management

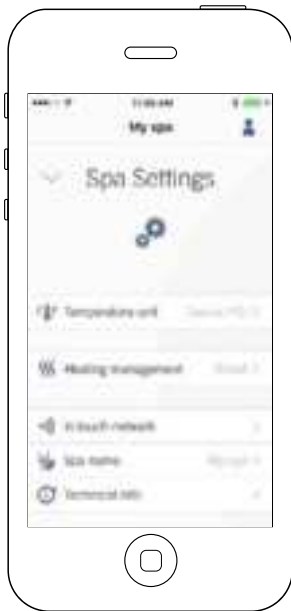

Heating management will appear when an in.grid is detected.

You can change your in.grid heating management without the need to open the spa skirt to change the jumper.

To do so, go to your Spa Settings - Heating management.

You can choose between 4 modes:

- Internal Heater
- External Heater
- Both
- Smart

To know more about the in.grid, take a look at our website at:

<http://geckoportal.com/ingrid>

Both in.touch 2 modules have a status LED to help diagnose problems, if any occur.

Troubleshooting

There are 2 different modules in the in.touch 2 kit: The Home Transmitter (EN Module) and the Spa Transmitter (CO Module). They communicate together via an RF link. The Home Transmitter is responsible for the Ethernet communications and the Spa Transmitter is responsible for the spa communications.

WIRING DIAGRAM - W3000

W3000



ELECTRICAL WIRING

ELECTRICAL WIRING: NORTH AMERICAN MODEL IN.YE

Refer to wiring diagram in the enclosure box lid for more information.

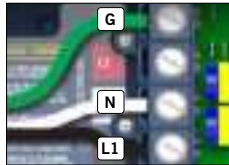

240 V (4 wires)

120 V (*3 wires)

* If connected to a 3 wires system, the heat.wave and accessories will not operate at 240 V.

Refer to the section « Connections for 120 V heaters ».

Note: To convert model to a 120 V system, white cables from the AMP connectors and from all accessories must be shunted. See wiring diagram for details.

Insert each wire into the appropriate socket of the main entry terminal block according to the color code indicated on the sticker. Use a flat-head screwdriver to tighten the screws on the terminal (please refer to the sticker inside the casing to see the torque to apply).

After making sure wires are securely connected, push them back into the box and replace the cover. Do not over tighten cover screws (torque to 8 in. lb max {0.9 N.m}).

Connect the bonding conductor to the bonding lug on the front of the spa pack (a grounded electrode conductor should be used to connect the equipment grounding conductors).

WIRING DIAGRAM - W3000

CONNECTIONS

CONNECTING HIGH VOLTAGE ACCESSORIES: ALL MODELS

Two options are available with Y Series spa packs for connecting high voltage accessories: 0.250" quick-connect terminals, or AMP connectors conform to industry standards.

CONNECTING HIGH VOLTAGE ACCESSORIES: NORTH AMERICAN MODEL IN.YE

For the connection to the 0.250 inch terminals, the high voltage accessories must be provided with female quick connect terminals, straight and non-insulated for all types of connections, including the ground. Accessories of 120 V or 240 V may be connected to the corresponding terminals of the printed circuit of the in.ye. Refer to the following tables for correct connections. Note that all female terminals must be correctly and completely seated on the printed circuit terminals for proper current ratings.

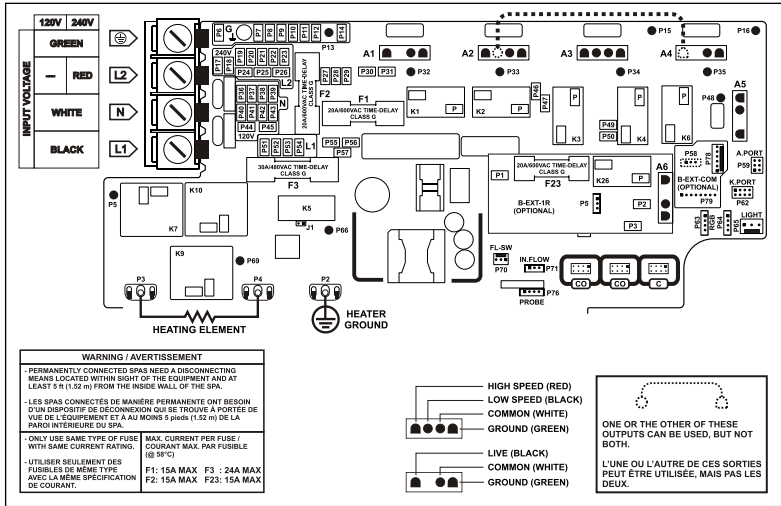

CONNECTION FOR MODEL WITHOUT AMP CONNECTORS:

DIRECT OUTPUT 1 (A5)

Voltage	120 V		240 V	
	P11	P11	P49	P24
Green / ground	P11	P11	P49	P24
Black / line	P49	P49	P44	P24
White / common	P44	P24		

PUMP 1 (A3)

Voltage	120 V		240 V	
	P8	P8	K2-P	K4-P
Green / ground	P8	P8	K2-P	K4-P
Black / low speed	K2-P	K2-P	K4-P	K4-P
Red / high speed	K4-P	K4-P		
White / common	P38	P21		

PUMP 2 (A2) (in.ye-5 only)

Voltage	120 V		240 V	
	P8	P8	K6-P	K3-P
Green / ground	P8	P8	K6-P	K3-P
Black / low speed	K6-P	K6-P	K3-P	K3-P
Red / high speed	K3-P	K3-P		
White / common	P37	P20		

PUMP 3 (A4) (in.ye-5 only)

Voltage	120 V		240 V	
	P10	P10	K6-P	P22
Green / ground	P10	P10	K6-P	P22
Black / line	K6-P	K6-P		
White / common	P39	P22		

Optional output (A26) (in.ye-4 or -6 only)

Voltage	120 V		240 V	
	P12	P12	K26-P	P45
Green / ground	P12	P12	K26-P	P45
Black / line	K26-P	K26-P	P45	P26
White / common	P45	P26		

Circulation pump* (A1)

Voltage	120 V		240 V	
	P7	P7	K1-P	P36
Green / ground	P7	P7	K1-P	P36
Black / line	K1-P	K1-P	P36	P19
White / common	P36	P19		

Pump 2 (A2) (in.ye-3 only)

Voltage	120 V		240 V	
	P8	P8	K2-P	P37
Green / ground	P8	P8	K2-P	P37
Black / low speed	K2-P	K2-P	P37	P20
White / common	P37	P20		

Light (12 V dc, 1.3 A Max.)**

P65

LEDs RGB (in.lu.me only)

P63; P64

* Ozonator and circulation pump can be combined on the same output via the optional splitter PP1.

** Max. available current for Light and LEDs RGB together.

This table shows typical connections. OEMs may have a different connection scheme.

WIRING DIAGRAM - W3000

CONNECTIONS

HEAT.WAV WATER HEATER CONNECTIONS

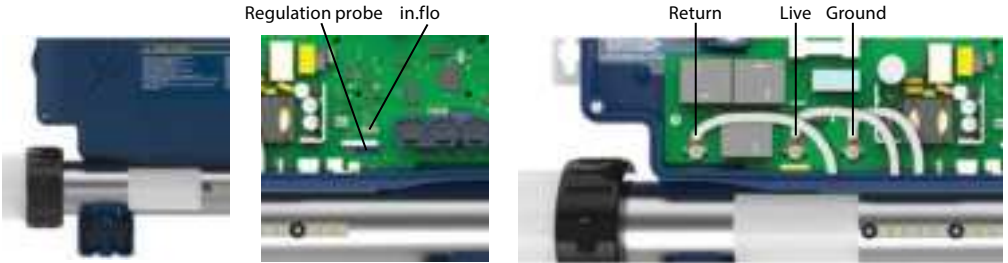

in.ye systems come with a high performance heat.wav heater. With no pressure switch, it features in.flo integrated dry-fire protection.

The heat.wav heater is factory configured for 240 V / 4 kW, but it can be converted to a dedicated 120 V / 1 kW by simply adding a cable connection. (120 V conversion is available on North American in.ye-3 models only).

The heat.wav heater is also offered in 240 V / 5,5 kW or 240 V / 2 kW versions.

heat.wav specification summary:

- Supports 120 V or 240 V
- Incoloy® heater element
- Protected by external breaker (not fused)*

**Note: European models are 230-240 V only and are fuse protected.*

Part numbers:

9917-101959 (cable for conversion)

9920-101449 (5.5 kW heat.wav heater)

All heater connections are accessible when the cover is removed. These previously mentioned connections are installed from manufacturing and must not be removed. Connections include the in.flo dry-fire protection, hi-limit/regulation probe connectors, power and ground cable connections.

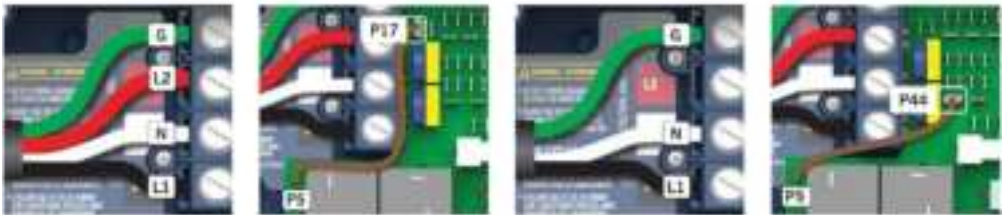

Connections for 240 V heaters (North American installations only)

BROWN wire must be correctly connected between P5 and P17.

Connections for 120 V heaters (1 kW)

BROWN wire must be correctly connected between P5 and P44.

Note: To convert model to a 120 V system, whites cables from the AMP connectors and from all accessories must be shunted. See wiring diagram for details.

WIRING DIAGRAM - W3000

ELECTRICAL WIRING

ELECTRICAL WIRING : ALL MODELS



Warning

Disconnect power before starting electrical work. Wiring must be completed by a qualified electrician and must be done in accordance with the local electrical code.

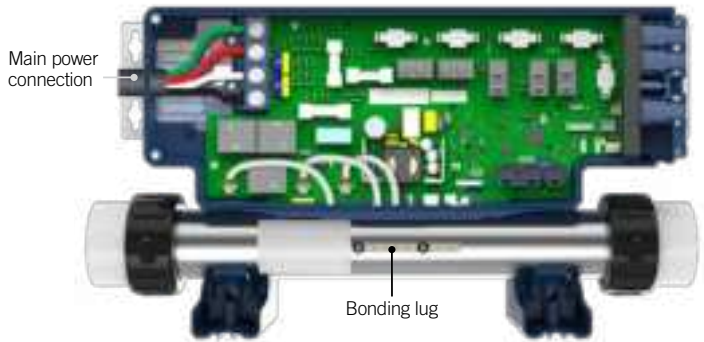

To complete the electrical connections of our in,ye control system you will need a Phillips screwdriver and a flat-head screwdriver (slotted head size between 5/16" and 3/8").

Remove the screws from the system control lid and remove it.

Remove 5 1/2" (142 mm) of cable insulation.

Strip away 1" (25 mm) of insulation from each wire.

Pull the cable through the cutout of the box and secure it with a NPT strain relief* (hole diameter 1,335" [34,42 mm]). Ensure that the NPT strain relief clamps are around the outer sheath of the cable.

* For CE use an IEC certified plastic bushing that will maintain the IPX5 rating.

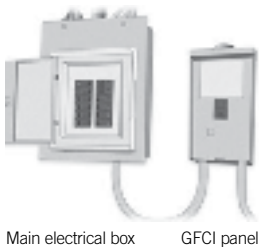

Main electrical box

GFCI panel



Warning

For units to be installed in other than single-family dwellings, a clearly labeled emergency switch shall be provided as part of the installation. The switch shall be readily accessible to the occupants and shall be installed at least 5' (1.52 m) away, adjacent to, and within sight of the unit.

This product must always be connected to a circuit protected by a ground fault interrupter.

Proper wiring of the electrical service box, GFCI and in,ye terminal block is essential!

Check your electrical code for local regulations. Only copper wire should be used, never aluminum.



Disposal of the product

The appliance (or the product) must be disposed of separately in accordance with the local waste disposal legislation in force.

BREAKER SETTING

FOR COLOR DISPLAY KEYPAD GO IN SETTING MENU



It is important to specify the current rating of the GFCI/RCD used to ensure a safe and efficient current management (and reduce nuisance GFCI/RCD trippings).

Choose the number of phases supplying your spa (1 to 3). Use the **Up** or **Down** keys to select the number of phases and press on the **Prog.** key to confirm your selection.

W3000 Selecting number of phases

CE	1, 2 or 3
CE Swim*	1, 2 or 3

*** For more information see the Swim spa system Techbook.**

The values displayed by the system correspond to 80% of the maximum amperage capacity of the GFCI.

Use the Up or Down keys to choose the desired value.

The value can typically be modified from 10 to 48 A.

Press on the Prog. key to set the breaker rating.

The tables below indicate the typical value of b for different GFCI/RCD ratings.

Choose the one that corresponds to your breaker.

Note: Every OEM has its own pre-established configurations.

REQUIRED GFCI/RCD - AMPERAGE SETTINGS

W3000

GFCI/RCD	b
60A	48A
50A	40A
40A	32A
30A	24A
20A	16A

POWER UP

IMPORTANT Please read the following before starting the device.

Verify that all accessories are linked to the ground lug and connected to the to the control system.

A minimum flow of 68 LPM (18 GPM) is required. Make sure that all valves are open in the hot tub plumbing and that the water flow is sufficient between the main pump and the water heater.

Turn on the breaker.

IN.FLO DRY-FIRE PROTECTION

At start up, the in.flo's detector verifies the water flow according to the following sequence:

The Pump 1 or the circulation pump runs for a period of 2 to 5 minutes.

The display will show "--" during the flow verification. After this time, the system confirms if flow is adequate or not.

If the flow is sufficient, the temperature of the water is displayed on the keypad screen. When the water has reached the consigned temperature plus 0.45°C (0.8°F), the water heater turns off.

DISPLAY SEQUENCE AT START UP (EVERY PARAMETER IS DISPLAYED FOR 2 SECONDS)

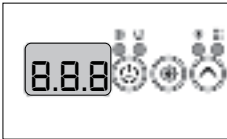

Lamp test

All segments and LEDs light up.

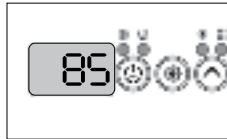

Software number

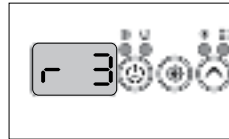

Software revision

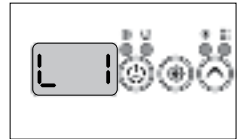

Low-level selected

Low-level selected from the low-level menu.

COMMON HARDWARE ISSUES

Problem	Usual Cause	Solution
System not operating	<ul style="list-style-type: none"> – House circuit breaker tripped or in OFF position 	<ul style="list-style-type: none"> – Reset circuit breaker on house breaker panel
Heater not operating	<ul style="list-style-type: none"> – Water level too low – Heater mode not selected – No power to heater – Heater not operating – Jets are closed 	<ul style="list-style-type: none"> – Add water to reach 6" (15.5 cm) below top lip of spa – Open all jets – Refer to temperature/heater functioning – Check house circuit breaker – Contact dealer
Water not clean	<ul style="list-style-type: none"> – Clogged or blocked floor suction or skimmer – Filter clogged (dirty) – Poor water chemistry – Insufficient filtering time – Improper maintenance – High content of solids in water 	<ul style="list-style-type: none"> – Clean floor suction/skimmer – Remove blockage – Clean or replace – See Maintenance section – Run filtration mode longer – Contact dealer – Use clarifier or drain and refill spa
Abnormal water usage	<ul style="list-style-type: none"> – Excessive evaporation and/or splashing 	<ul style="list-style-type: none"> – Use spa cover and refill as necessary
Overheating	<ul style="list-style-type: none"> – High ambient temperature 	<ul style="list-style-type: none"> – Contact dealer
Low water flow from jets	<ul style="list-style-type: none"> – Operating in FILTER mode-low speed – Clogged or blocked suction or skimmer – Dirty filter – Jets in OFF position – Slice valves closed 	<ul style="list-style-type: none"> – Select hi-speed jets – Clean floor suction/skimmer – Remove blockage – Clean or replace – Open jets – Contact dealer
Noisy pump and motor	<ul style="list-style-type: none"> – Clogged floor suction or skimmer – Low water level – Damaged or worn motor bearings 	<ul style="list-style-type: none"> – Clean floor suction/skimmer – Add water to normal water level (6" or 15.5 cm below lip) – Contact dealer
No water flow from jets	<ul style="list-style-type: none"> – Pump not primed – Adjustable jets turned off – House circuit breaker tripped, no power to system – Faulty pump or motor – Pump surges – Slice valves closed 	<ul style="list-style-type: none"> – See Priming section – Turn on jets – Reset circuit breaker at house panel – Low water. Check level on Weir door – Contact dealer
Water leakage from under spa	<ul style="list-style-type: none"> – Check unions & drain hoses 	<ul style="list-style-type: none"> – Close or tighten as necessary
No air flow from jets	<ul style="list-style-type: none"> – Air control not open – Jet nozzle not seated properly – Jet nozzle missing 	<ul style="list-style-type: none"> – Open control – Check jet nozzles – Inspect jets and replace as needed
Motor will not operate	<ul style="list-style-type: none"> – House circuit breaker tripped or in OFF position – Improper or defective wiring or electrical supply – Thermal Overload Protection switch tripped 	<ul style="list-style-type: none"> – Reset circuit breaker – Contact dealer – Auto reset after motor has cooled. Contact dealer if motor continues to cycle
The spa will not shut off	<ul style="list-style-type: none"> – Spa trying to heat – Spa is in filter cycle 	<ul style="list-style-type: none"> – Check Set Temperature – Check Filter Times

